



# 2022

fiyat listesi

E Y L Ü L

**TBLOC 2020 yılının Ocak ayında İzmir'de kurulmuş bir endüstri firmasıdır. Yeni bir firma olmasına rağmen kökleri uzun yıllara dayanan tecrübe ve birikimler nedeniyle çok derindedir. TBLOC, Türkiye'nin yeni bağlantı elemanları markası olarak Ar-Ge, Üretim ve Satış faaliyetlerini tek çatı altında yürütmekte ve bir Türk markası olarak uluslararası standartlarda ürettiği ürünleri tüm dünyaya ihraç etmektedir.**

**TBLOC markası, klemensin İngilizce karşılığı olan Terminal Block kelimelerinin bir kısaltması olarak görünse de "t" harfi teknolojinin kısaltması olarak markamızın başında, şirketimizin uzun vadeli planlarının göstergesi olarak yerini almıştır.**

## **Tbloc Kurumsal**

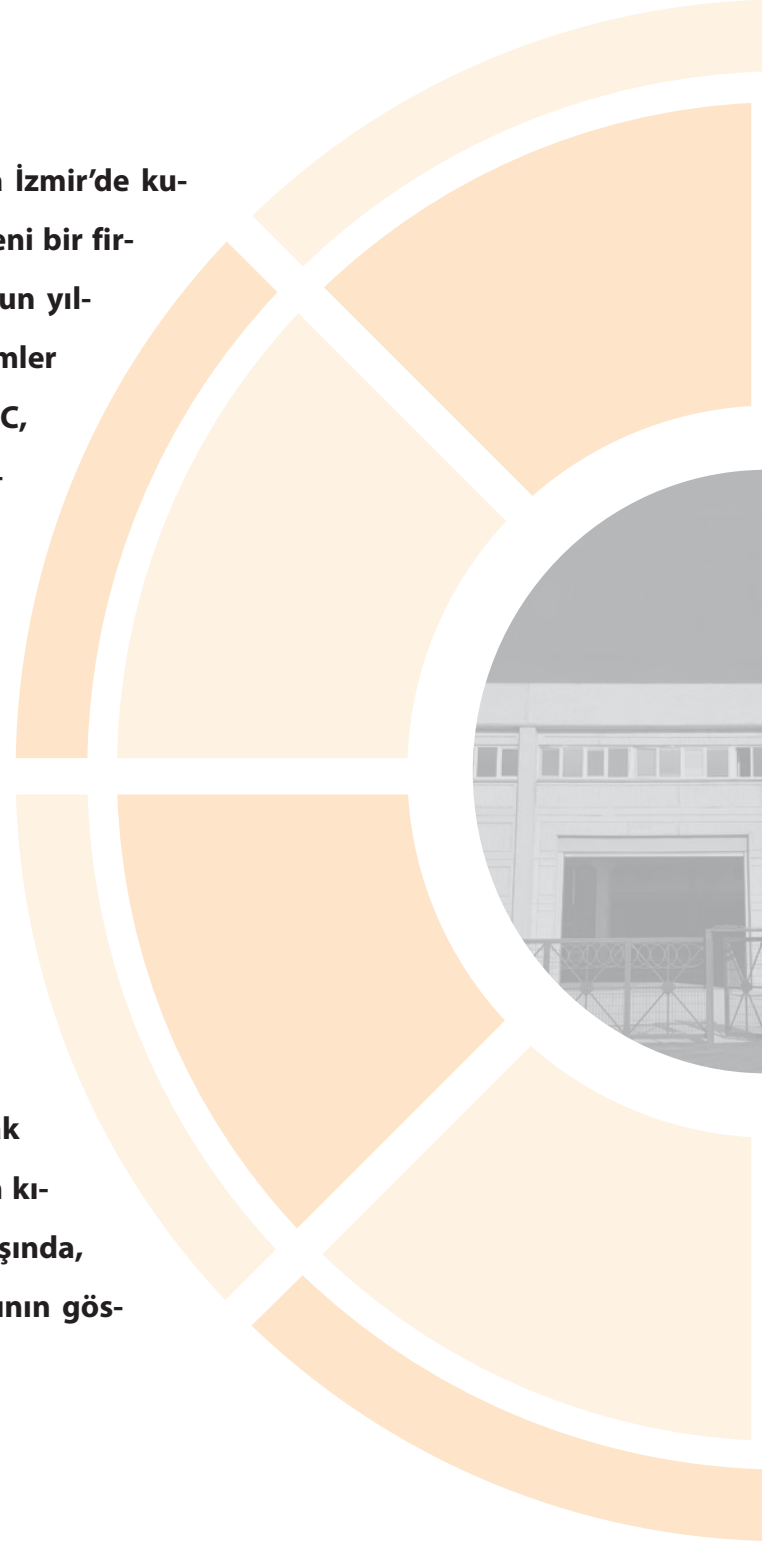



TBLOC is an industrial company established in January 2020 in İzmir/Turkey. Even though TBLOC is a new company, it has deep roots backed up with long years experience and knowledge. TBLOC, as a new brand in connectivity industry, is gathering all R&D, production and sales & marketing functions under one roof with the aim of becoming a global brand and supplying to international markets.

Despite TBLOC brand is being perceived as an abbreviation of Terminal Block definition, first letter "t" stands for technology and indicates our company's long term vision.

**Tbloc Corporate**

● <b>Klemensler ve Aksesuarları</b> Terminal Blocks and Accessories	<b>6 - 22</b>
● <b>Klemens Etiketleri</b> Marking Tags	<b>23 - 26</b>
● <b>Klemens Aksesuar Seçim Tablosu</b> Terminal Blocks Accessories Selection Table	<b>27 - 35</b>
● <b>Montaj Rayları ve Aksesuarları</b> Mounting Rails and Accessories	<b>36 - 37</b>
● <b>Müşterek W Otomat Baraları</b> PIN MCB Busbars	<b>38</b>
● <b>Kablo Kanalları</b> Wiring Ducts	<b>39 - 40</b>
● <b>Markalama Sistemleri</b> Marking Systems	<b>41 - 47</b>
● <b>Kablo Bağları ve Kroşeler</b> Cable Ties and Tie Mounts	<b>48 - 51</b>
● <b>Paslanmaz Çelik Kablo Bağları - 304 Kalite</b> Stainless Steel Cable Ties	<b>50</b>
● <b>Sıkmalı Kablo Pabuçları</b> Compression Cable Lugs	<b>52 - 54</b>
● <b>İzoleli ve İzolesiz Kablo Yüksükleri - İzoleli Kablo Pabuçları</b> Insulated and Non-Insulated End Sleeves - Insulated Cable Terminals	<b>55 - 61</b>
● <b>Ledli Sinyal Lambaları ve Kumanda Butonları</b> Led Indicators and Push Buttons	<b>62 - 69</b>

## Genel Şartlar

- Fiyatlara K.D.V. dahil değildir.
- Fiyat listemiz 1 Eylül 2022 tarihinden itibaren geçerli olan liste fiyatlarımızı içerir.
- Teslim anındaki fiyatlar geçerlidir.
- Önceden haber vermeksizin fiyat değiştirme hakkımız saklıdır.
- Sevkiyatlar standart ambalaja göre yapılır.
- Aksi bildirilmedikçe nakliye bedeli alıcıya aittir.
- Tbloc firmasının yazılı onayı olmadan iade kabul edilmeyecektir.
- Ürünlerimizde değişiklik yapma hakkımız saklıdır.
- İçeride görülen resim ve teknik değerler genel bilgi amaçlıdır.
- Listemizde bulamadığınız ürünler için lütfen satış birimimizle temasa geçiniz.



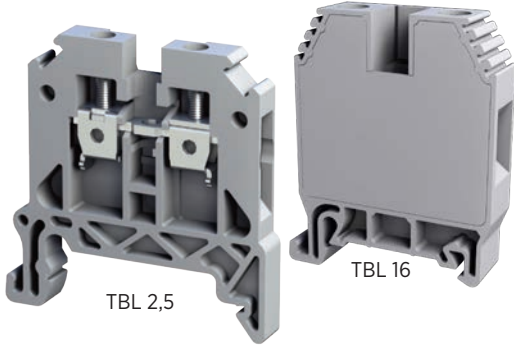

TBL 2,5

TBL 16



### TBL Serisi Geçiş Klemensleri

#### TBL Series Feed Through Terminal Block

Ürün Kodu Product Code	Ürün Adı Product Name	Açıklama Explanation	Kesit Cross Sec. (mm <sup>2</sup> )	Renk Color	Amb. Mik. Pack. Qty (Adet/Pcs.)	Koli Mik. Box.Qty. (Adet/Pcs.)	Birim Fiyatı Unit Price (TL/Adet)
8000099008	TBL 2,5	Geçiş Klemensi / Feed Through Terminal Block	2,5	Gri / Grey	100	1.000	7,80
8000099028	TBL 4	Geçiş Klemensi / Feed Through Terminal Block	4	Gri / Grey	100	1.000	9,20
8000099038	TBL 6	Geçiş Klemensi / Feed Through Terminal Block	6	Gri / Grey	80	1.200	13,00
8000099048	TBL 10	Geçiş Klemensi / Feed Through Terminal Block	10	Gri / Grey	60	900	17,00
8000099058	TBL 16	Geçiş Klemensi / Feed Through Terminal Block	16	Gri / Grey	50	500	27,50
8000099068	TBL 25	Geçiş Klemensi / Feed Through Terminal Block	25	Gri / Grey	50	500	44,00
8000099078	TBL 35	Geçiş Klemensi / Feed Through Terminal Block	35	Gri / Grey	20	320	58,00
8000099088	TBL 50	Geçiş Klemensi / Feed Through Terminal Block	50	Gri / Grey	20	200	142,00

Renk Kodları / Color Codes

800009900.... ...0 ...1 ...2 ...3 ...4 ...5 ...6 ...9

Farklı renklerdeki klemens siparişlerinizi yukarıdaki renk skalasında verilen kodlara uygun olarak oluşturabilirsiniz.

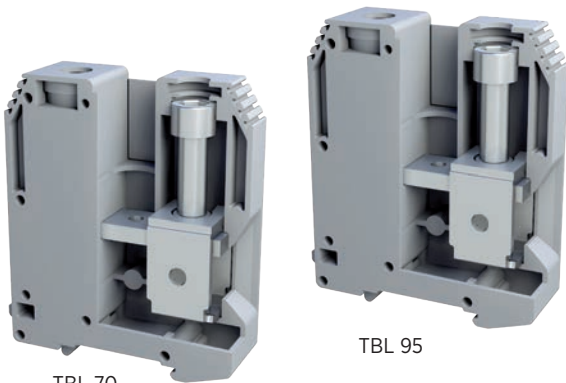

TBL 70

TBL 95



8000099098	TBL 70	Geçiş Klemensi / Feed Through Terminal Block	70	Gri / Grey	10	50	200,00
8000099108	TBL 95	Geçiş Klemensi / Feed Through Terminal Block	95	Gri / Grey	5	50	255,00
8000099106	TBL 95	Geçiş Klemensi / Feed Through Terminal Block	95	Mavi / Bule	5	50	255,00
8000099118	TBL 150	Geçiş Klemensi / Feed Through Terminal Block	150	Gri / Grey	5	50	340,00
8000099116	TBL 150	Geçiş Klemensi / Feed Through Terminal Block	150	Mavi / Blue	5	50	340,00

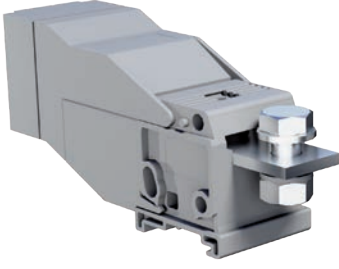

TBB 70



C-TBB 70-95-150



### Yüksek Akım Klemensi

#### High Current Terminal Blocks

Ürün Kodu Product Code	Ürün Adı Product Name	Açıklama Explanation	Kesit Cross Sec. (mm <sup>2</sup> )	Renk Color	Amb. Mik. Pack. Qty (Adet/Pcs.)	Koli Mik. Box.Qty. (Adet/Pcs.)	Birim Fiyatı Unit Price (TL/Adet)
8000099128	<b>TBB 70</b>	Yüksek Akım Klemensi / High Current Terminal Blocks	70	Gri / Grey	5	50	<b>245,00</b>
8000099138	<b>TBB 95</b>	Yüksek Akım Klemensi / High Current Terminal Blocks	95	Gri / Grey	5	50	<b>255,00</b>
8000099148	<b>TBB 150</b>	Yüksek Akım Klemensi / High Current Terminal Blocks	150	Gri / Grey	5	50	<b>355,00</b>
8000099158	<b>TBB 240</b>	Yüksek Akım Klemensi / High Current Terminal Blocks	240	Gri / Grey	4	40	<b>552,00</b>

#### Koruma Kapakları / Isolation Covers

8012396608	<b>C-TBB 70-95-150</b>	Koruma Kapağı / Isolation Cover	70-150	Gri / Grey	8	150	<b>52,80</b>
8012396618	<b>C-TBB 240</b>	Koruma Kapağı / Isolation Cover	240	Gri / Grey	10	150	<b>67,10</b>

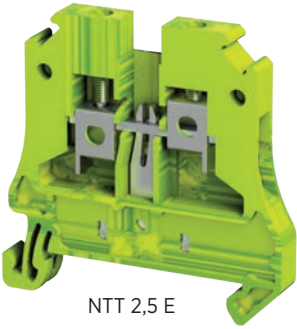

NTT 2,5 E







TBL 16 E



### Vida Bağlantılı Topraklama Klemensleri

#### Screw Connection Earth Terminal Block

Ürün Kodu Product Code	Ürün Adı Product Name	Açıklama Explanation	Kesit Cross Sec. (mm <sup>2</sup> )	Renk Color	Amb. Mik. Pack. Qty (Adet/Pcs.)	Koli Mik. Box.Qty. (Adet/Pcs.)	Birim Fiyatı Unit Price (TL/Adet)
8001099214	<b>NTT 2,5 E</b> 	Topraklama Klemensi / Earth Terminal Blocks	2,5	Sarı-Yeşil / Yellow-Green	50	500	<b>31,00</b>
8001099224	<b>NTT 4 E</b> 	Topraklama Klemensi / Earth Terminal Blocks	4	Sarı-Yeşil / Yellow-Green	50	500	<b>35,50</b>
8001099234	<b>NTT 6 E</b> 	Topraklama Klemensi / Earth Terminal Blocks	6	Sarı-Yeşil / Yellow-Green	25	500	<b>47,00</b>
8001099244	<b>NTT 10 E</b> 	Topraklama Klemensi / Earth Terminal Blocks	10	Sarı-Yeşil / Yellow-Green	20	400	<b>55,00</b>
8001099194	<b>TBL 16 E</b>	Topraklama Klemensi / Earth Terminal Blocks	16	Sarı-Yeşil / Yellow-Green	20	340	<b>74,50</b>
8001099204	<b>TBL 35 E</b>	Topraklama Klemensi / Earth Terminal Blocks	35	Sarı-Yeşil / Yellow-Green	20	200	<b>138,00</b>

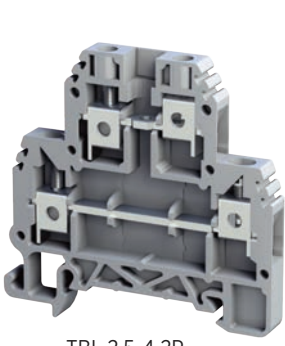

TBL 2,5-4 2P

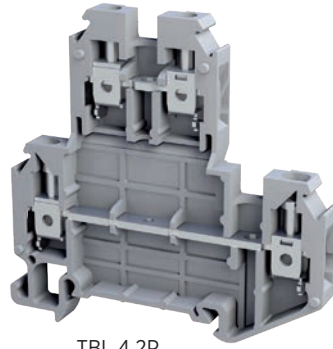

TBL 4 2P

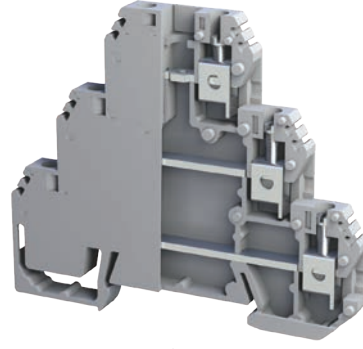

TBL 4 3P



### Vida Bağlantılı Çok Katlı Klemensler

#### Screw Type Multilevel Terminal Blocks

Ürün Kodu Product Code	Ürün Adı Product Name	Açıklama Explanation	Kesit Cross Sec. (mm <sup>2</sup> )	Renk Color	Amb. Mik. Pack. Qty. (Adet/Pcs.)	Koli Mik. Box.Qty. (Adet/Pcs.)	Birim Fiyatı Unit Price (TL/Adet)
8002099438	TBL 2,5-4 2P	2 katlı geçiş klemensi 2 levels feed through terminal blocks	2,5 - 4	Gri / Grey	50	600	25,00
8002099258	TBL 4 2P	2 katlı geçiş klemensi 2 levels feed through terminal blocks	4	Gri / Grey	50	800	31,50
8002099488	TBL 10 2P	2 katlı geçiş klemensi 2 levels feed through terminal blocks	10	Gri / Grey	25	300	68,00
8002099478	TBL 4 3P	3 katlı geçiş / 3 levels feed through	4	Gri / Grey	25	500	60,00

Renk Kodları / Color Codes	...	...	...	...	...	...	...
800009900...	...0	...1	...2	...3	...4	...5	...6

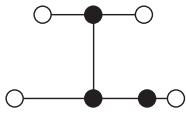

8002099428  
TBL 4 2PK

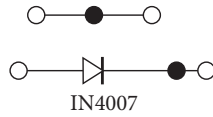

8002099268  
TBL 4 2P X1

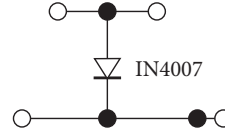

8002099278  
TBL 4 2P X2

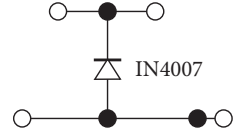

8002099288  
TBL 4 2P X3

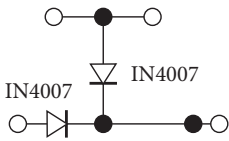

8002099298  
TBL 4 2P X4

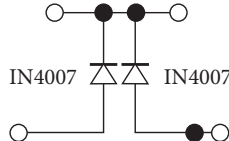

8002099305 TBL 4 2P X5  
8002099318  
TBL 4 2P X5 Gri

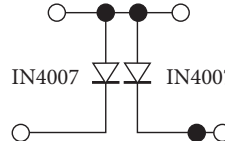

8002099328  
TBL 4 2P X6

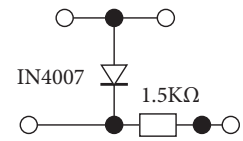

8002099348  
TBL 4 2P X8

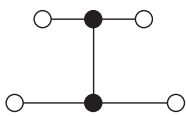

8002099448  
TBL 2,5-4 2PK

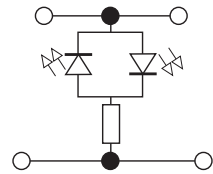

8002099458  
TBL 2,5-4 2PL (24-48VAC/DC) Gri  
8002099468  
TBL 2,5-4 2PL (110-220VAC/DC) Gri

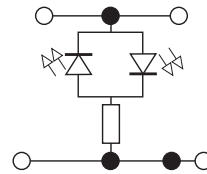

8002099368  
TBL 4 2PL (24-48VAC/DC) Gri  
8002099378  
TBL 4 2PL (110-220VAC/DC) Gri



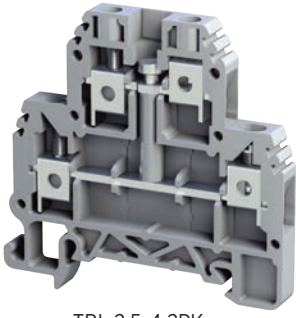

TBL 2,5-4 2PK





TBL 4 2P X1



### Vida Bağlantılı Çok Katlı Klemensler

#### Screw Type Multilevel Terminal Blocks

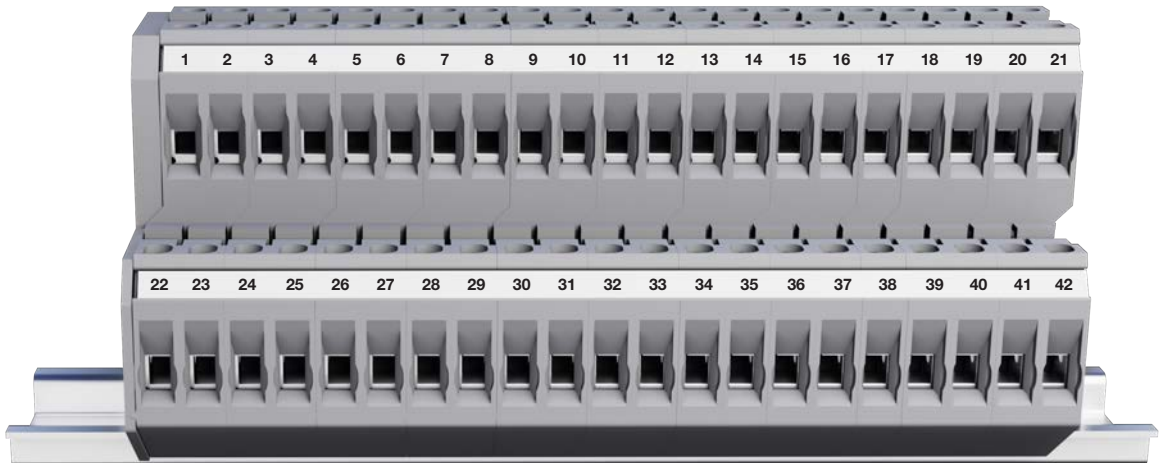

Ürün Kodu Product Code	Ürün Adı Product Name	Açıklama Explanation	Kesit Cross Sec. (mm <sup>2</sup> )	Renk Color	Amb. Mik. Pack. Qty (Adet/Pcs.)	Koli Mik. Box.Qty. (Adet/Pcs.)	Birim Fiyatı Unit Price (TL/Adet)
8002099448	TBL 2,5-4 2PK	2 katlı içeriden köprülü 2 levels internally bridged	2,5 - 4	Gri / Grey	50	600	54,00
8002099458	TBL 2,5-4 2PL(24-48VAC/DC) 	2 katlı ledli ve diyotlu 2 levels with led and diode	2,5 - 4	Gri / Grey	50	600	80,50
8002099468	TBL 2,5-4 2PL(110-220VAC/DC) 	2 katlı ledli ve diyotlu 2 levels with led and diode	2,5 - 4	Gri / Grey	50	600	80,50
8002099268	TBL 4 2P X1	2 katlı diyotlu 2 levels with diode	4	Gri / Grey	50	800	62,00
8002099278	TBL 4 2P X2	2 katlı diyotlu 2 levels with diode	4	Gri / Grey	50	800	62,00
8002099288	TBL 4 2P X3	2 katlı diyotlu 2 levels with diode	4	Gri / Grey	50	800	62,00
8002099298	TBL 4 2P X4	2 katlı diyotlu 2 levels with diode	4	Gri / Grey	50	800	62,00
8002099318	TBL 4 2P X5	2 katlı diyotlu 2 levels with diode	4	Gri / Grey	50	800	62,00
8002099305	TBL 4 2P X5 	2 katlı diyotlu 2 levels with diode	4	Yeşil / Green	50	800	62,00
8002099328	TBL 4 2P X6	2 katlı diyotlu 2 levels with diode	4	Gri / Grey	50	800	62,00
8002099338	TBL 4 2P X7	2 katlı diyotlu 2 levels with diode	4	Gri / Grey	50	800	62,00
8002099348	TBL 4 2P X8	2 katlı diyotlu 2 levels with diode	4	Gri / Grey	50	800	62,00
8002099368	TBL 4 2PL(24-48VAC/DC)	2 katlı ledli ve diyotlu 2 levels with led and diode	4	Gri / Grey	50	800	97,70
8002099378	TBL 4 2PL(110-220VAC/DC)	2 katlı ledli ve diyotlu 2 levels with led and diode	4	Gri / Grey	50	800	97,70
8002099428	TBL 4 2PK	2 katlı içeriden köprülü 2 levels internally bridged	4	Gri / Grey	50	800	59,00

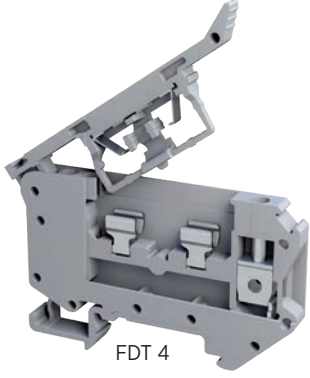



### Vida Bağlantılı Sigortalı ve Bıçaklı Ayırma Klemensleri

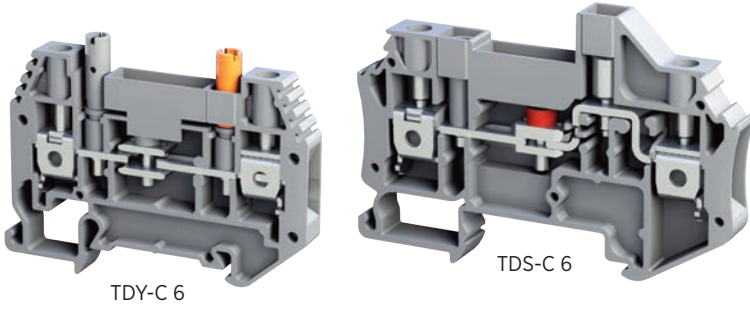

#### Screw Type Fuse and Disconnect Terminal Blocks

Ürün Kodu Product Code	Ürün Adı Product Name	Açıklama Explanation	Kesit Cross Sec. (mm <sup>2</sup> )	Renk Color	Amb. Mik. Pack. Qty (Adet/Pcs.)	Koli Mik. Box.Qty. (Adet/Pcs.)	Birim Fiyatı Unit Price (TL/Adet)
8003099488	FDT 4 	Sigortalı Ayırma Klemensi Fuse and Disconnect Terminal	4	Gri / Grey	25	500	45,00
8003099486	FDT 4  ●	Sigortalı Ayırma Klemensi Fuse and Disconnect Terminal	4	Gri / Grey	25	500	45,00
8003099498	FDT 4 L (24-48 VAC/DC)	Sigortalı Ayırma Klemensi Fuse and Disconnect Terminal	4	Gri / Grey	25	500	102,00
8003099508	FDT 4 L (110-220 VAC/DC)	Sigortalı Ayırma Klemensi Fuse and Disconnect Terminal	4	Gri / Grey	25	500	102,00
8003099496	FDT 4 L (24-48 VAC/DC) ●	Sigortalı Ayırma Klemensi Fuse and Disconnect Terminal	4	Mavi / Blue	25	500	102,00
8003099518	FDT 4 L (110-220 VAC)	Sigortalı Ayırma Klemensi Fuse and Disconnect Terminal	4	Gri / Grey	25	500	102,00
8003099506	FDT 4 L (110-220 VAC/DC) ●	Sigortalı Ayırma Klemensi Fuse and Disconnect Terminal	4	Mavi / Blue	25	500	102,00
8003099528	TBL 2,5 S	Ayırma Klemensi Disconnect Terminal	2,5	Gri / Grey	50	900	37,00



**Vidalı Ölçme Ayırma Klemensleri**

Screw Type Test and Disconnect Terminal Blocks

Ürün Kodu Product Code	Ürün Adı Product Name	Açıklama Explanation	Kesit Cross Sec. (mm <sup>2</sup> )	Renk Color	Amb. Mik. Pack. Qty (Adet/Pcs.)	Koli Mik. Box.Qty. (Adet/Pcs.)	Birim Fiyatı Unit Price (TL/Adet)
8004099808	<b>TDT-C 6</b> 	Ölçme Ayırma Klemensi Test and Disconnect Terminal	6	Gri / Grey	20	320	<b>85,00</b>
8004099818	<b>TDT-V 6</b>	Ölçme Ayırma Klemensi Test and Disconnect Terminal	6	Gri / Grey	20	320	<b>85,00</b>
8004099828	<b>TDS-C 6</b> 	Ölçme Ayırma Klemensi Test and Disconnect Terminal	6	Gri / Grey	25	500	<b>79,50</b>
8004099838	<b>TDV-C 6</b>	Ölçme Ayırma Klemensi Test and Disconnect Terminal	6	Gri / Grey	25	500	<b>79,50</b>
8004099848	<b>TDS-V 6</b>	Ölçme Ayırma Klemensi Test and Disconnect Terminal	6	Gri / Grey	25	500	<b>79,50</b>
8004099858	<b>TDY-C 6</b> 	Ölçme Ayırma Klemensi Test and Disconnect Terminal	6	Gri / Grey	25	500	<b>90,00</b>

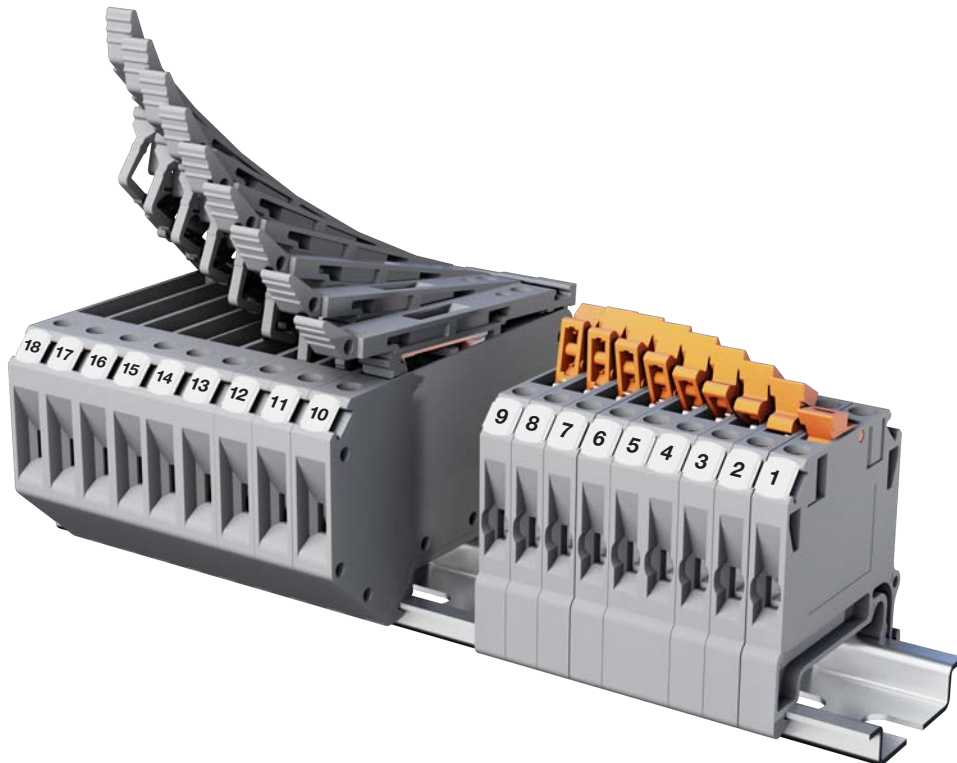

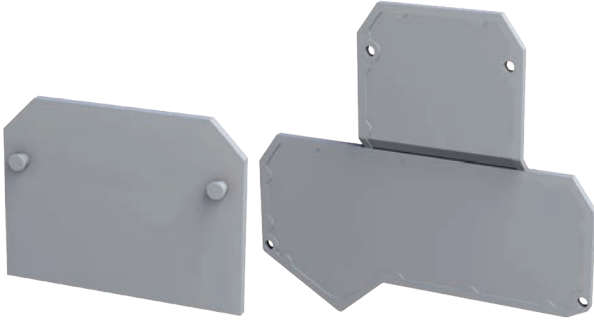

EPL TBL 2,5-10

EPL2 TBL 4 2P

#### Nihayet Plakaları

##### End Plates

Ürün Kodu Product Code	Ürün Adı Product Name	Açıklama Explanation	Kesit Cross Sec. (mm <sup>2</sup> )	Renk Color	Amb. Mik. Pack. Qty (Adet/Pcs.)	Birim Fiyatı Unit Price (TL/Adet)
8012396118	<b>EPL TBL 2,5-10</b>	Nihayet Plakası / End Plate	2,5 - 10	Gri / Grey	50	<b>5,80</b>
8012396208	<b>EPL TBL 2,5-4 2P</b>	Nihayet Plakası / End Plate	2,5 - 4	Gri / Grey	20	<b>11,50</b>
8012396218	<b>EPL1 TBL 4 2P</b>	Nihayet Plakası / End Plate	4	Gri / Grey	20	<b>12,20</b>
8012396228	<b>EPL2 TBL 4 2P</b>	Nihayet Plakası / End Plate	4	Gri / Grey	20	<b>12,20</b>
8012396238	<b>EPL3 TBL 4 2P</b>	Nihayet Plakası / End Plate	4	Gri / Grey	20	<b>12,20</b>
8012396018	<b>EPL TDS</b>	Nihayet Plakası / End Plate	6	Gri / Grey	50	<b>14,00</b>
8012396028	<b>EPL TDV</b>	Nihayet Plakası / End Plate	6	Gri / Grey	50	<b>14,00</b>
8012396038	<b>EPL TDY</b>	Nihayet Plakası / End Plate	6	Gri / Grey	50	<b>14,00</b>

##### Renk Kodları / Color Codes

800009900....	...0	...1	...2	...3	...4	...5	...6	...9
---------------	------	------	------	------	------	------	------	------

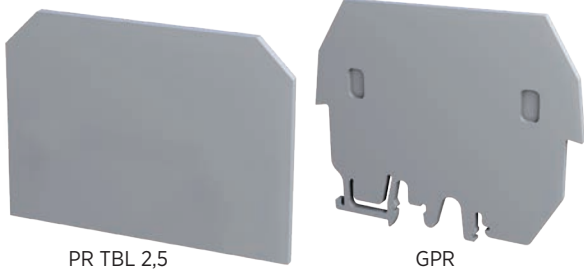

PR TBL 2,5

GPR

#### Ayırma Plakaları

##### Partition Plates

Ürün Kodu Product Code	Ürün Adı Product Name	Açıklama Explanation	Kesit Cross Sec. (mm <sup>2</sup> )	Renk Color	Amb. Mik. Pack. Qty (Adet/Pcs.)	Birim Fiyatı Unit Price (TL/Adet)
8012396406	<b>PR TBL 2,5-10</b> ●	Ayırma Plakası / Partition Plate	2,5 - 10	Mavi / Blue	50	<b>9,70</b>
8012396408	<b>PR TBL 2,5-10</b>	Ayırma Plakası / Partition Plate	2,5 - 10	Gri / Grey	50	<b>9,70</b>
8012396508	<b>PR TBL 4 2P</b>	Ayırma Plakası / Partition Plate	4	Gri / Grey	20	<b>11,50</b>
8012396528	<b>SPR 2,5-10</b>	Ayırma Plakası / Partition Plate	2,5 - 10	Gri / Grey	100	<b>5,40</b>
8012396538	<b>SPR 16-35</b>	Ayırma Plakası / Partition Plate	16 - 35	Gri / Grey	50	<b>12,30</b>
8012396548	<b>SPR 50</b>	Ayırma Plakası / Partition Plate	50	Gri / Grey	50	<b>19,00</b>
8012396558	<b>SPR TBL 4 2P</b>	Ayırma Plakası / Partition Plate	4	Gri / Grey	100	<b>7,00</b>
8012396566	<b>GPR</b> ●	Genel Ayırma Plakası / General Partition Plate	16 -50	Mavi / Blue	20	<b>15,50</b>
8012396568	<b>GPR</b>	Genel Ayırma Plakası / General Partition Plate	16 -50	Gri / Grey	20	<b>15,50</b>



TST 4



TST 2



TST 1

### Test Fişleri

#### Test Sockets

Ürün Kodu Product Code	Ürün Adı Product Name	Açıklama Explanation	Renk Color	Amb. Mik. Pack. Qty (Adet/Pcs.)	Birim Fiyatı Unit Price (TL/Adet)
8014393106	TST-I 1	● Test Fişi / Test Plug	Mavi / Blue	50	15,40
8014393104	TST-I 1	● Test Fişi / Test Plug	Sarı / Yellow	50	15,40
8014393108	TST-I 1	● Test Fişi / Test Plug	Gri / Grey	50	15,40
8014393102	TST-I 1	● Test Fişi / Test Plug	Kırmızı / Red	50	15,40
8014393100	TST-I 1	● Test Fişi / Test Plug	Siyah / Black	50	15,40
8014393227	TST 1	Test Fişi / Test Plug		50	13,20
8014393237	TST 2	Test Fişi / Test Plug		50	13,20
8014393247	TST 3	Test Fişi / Test Plug		50	13,20
8014393257	TST 4	Test Fişi / Test Plug		50	13,20

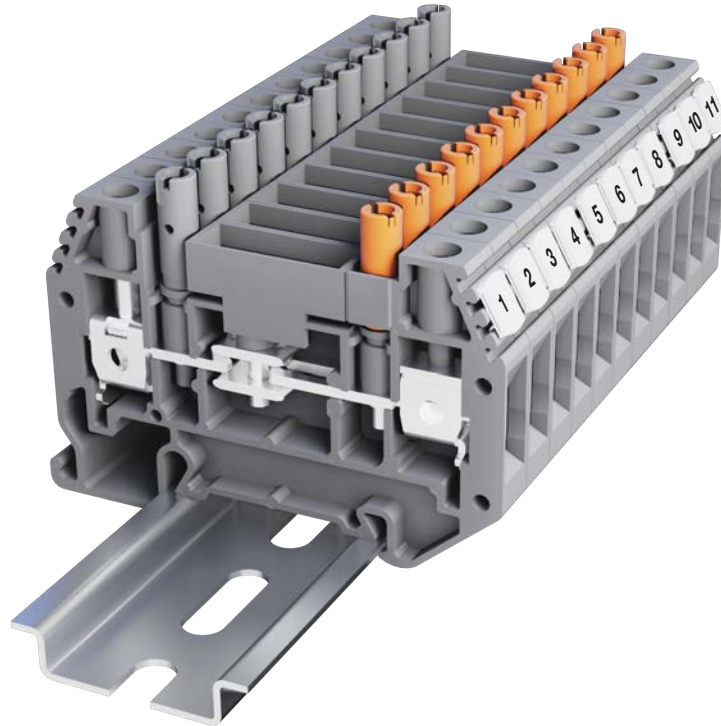



### Üst Köprüler

#### Cross Connections

Ürün Kodu Product Code	Ürün Adı Product Name	Açıklama Explanation	Pin Pole	Kesit Cross Sec. (mm <sup>2</sup> )	Amb. Mik. Pack. Qty (Adet/Pcs.)	Birim Fiyatı Unit Price (TL/Adet)
8013095023	<b>SCC 2,5/2</b>	TBL Serisi Vidalı Üst Köprü / TBL Series Screw Cross Connection	2	2,5	50	<b>13,20</b>
8013095033	<b>SCC 2,5/3</b>	TBL Serisi Vidalı Üst Köprü / TBL Series Screw Cross Connection	3	2,5	50	<b>20,40</b>
8013095003	<b>SCC 2,5/10</b>	TBL Serisi Vidalı Üst Köprü / TBL Series Screw Cross Connection	10	2,5	10	<b>60,00</b>
8013095123	<b>SCC 4/2</b>	TBL Serisi Vidalı Üst Köprü / TBL Series Screw Cross Connection	2	4	50	<b>16,20</b>
8013095133	<b>SCC 4/3</b>	TBL Serisi Vidalı Üst Köprü / TBL Series Screw Cross Connection	3	4	50	<b>25,20</b>
8013095103	<b>SCC 4/10</b>	TBL Serisi Vidalı Üst Köprü / TBL Series Screw Cross Connection	10	4	10	<b>66,00</b>
8013095223	<b>SCC 6/2</b>	TBL Serisi Vidalı Üst Köprü / TBL Series Screw Cross Connection	2	6	50	<b>16,80</b>
8013095233	<b>SCC 6/3</b>	TBL Serisi Vidalı Üst Köprü / TBL Series Screw Cross Connection	3	6	50	<b>21,60</b>
8013095203	<b>SCC 6/10</b>	TBL Serisi Vidalı Üst Köprü / TBL Series Screw Cross Connection	10	6	10	<b>64,80</b>
8013095323	<b>SCC 10/2</b>	TBL Serisi Vidalı Üst Köprü / TBL Series Screw Cross Connection	2	6	50	<b>19,80</b>
8013095333	<b>SCC 10/3</b>	TBL Serisi Vidalı Üst Köprü / TBL Series Screw Cross Connection	3	10	50	<b>25,80</b>
8013095303	<b>SCC 10/10</b>	TBL Serisi Vidalı Üst Köprü / TBL Series Screw Cross Connection	10	10	10	<b>75,60</b>
8013095423	<b>SCC 16/2</b>	TBL Serisi Vidalı Üst Köprü / TBL Series Screw Cross Connection	2	10	20	<b>26,00</b>
8013095433	<b>SCC 16/3</b>	TBL Serisi Vidalı Üst Köprü / TBL Series Screw Cross Connection	3	16	20	<b>33,60</b>
8013095403	<b>SCC 16/10</b>	TBL Serisi Vidalı Üst Köprü / TBL Series Screw Cross Connection	10	16	10	<b>110,40</b>
8013095523	<b>SCC 25/2</b>	TBL Serisi Vidalı Üst Köprü / TBL Series Screw Cross Connection	2	16	20	<b>25,20</b>
8013095533	<b>SCC 25/3</b>	TBL Serisi Vidalı Üst Köprü / TBL Series Screw Cross Connection	3	25	20	<b>34,80</b>
8013095503	<b>SCC 25/10</b>	TBL Serisi Vidalı Üst Köprü / TBL Series Screw Cross Connection	10	25	10	<b>105,60</b>
8013095623	<b>SCC 35/2</b>	TBL Serisi Vidalı Üst Köprü / TBL Series Screw Cross Connection	2	25	20	<b>33,00</b>
8013095633	<b>SCC 35/3</b>	TBL Serisi Vidalı Üst Köprü / TBL Series Screw Cross Connection	3	35	20	<b>45,00</b>
8013095603	<b>SCC 35/10</b>	TBL Serisi Vidalı Üst Köprü / TBL Series Screw Cross Connection	10	35	10	<b>132,00</b>
8013095723	<b>SCC 50/2</b>	TBL Serisi Vidalı Üst Köprü / TBL Series Screw Cross Connection	2	50	10	<b>72,00</b>
8013095733	<b>SCC 50/3</b>	TBL Serisi Vidalı Üst Köprü / TBL Series Screw Cross Connection	3	50	10	<b>100,80</b>
8013095823	<b>SCC 70/2</b>	TBL Serisi Vidalı Üst Köprü / TBL Series Screw Cross Connection	2	70	10	<b>144,00</b>
8013095833	<b>SCC 70/3</b>	TBL Serisi Vidalı Üst Köprü / TBL Series Screw Cross Connection	3	70	10	<b>186,00</b>
8013095923	<b>SCC 95/2</b>	TBL Serisi Vidalı Üst Köprü / TBL Series Screw Cross Connection	2	95	10	<b>132,00</b>
8013095933	<b>SCC 95/3</b>	TBL Serisi Vidalı Üst Köprü / TBL Series Screw Cross Connection	3	95	10	<b>160,00</b>
8013094023	<b>SCC 150/2</b>	TBL Serisi Vidalı Üst Köprü / TBL Series Screw Cross Connection	2	150	10	<b>198,00</b>
8013094123	<b>SCC 4/2 TBL 4 2P</b>	TBL Serisi Vidalı Üst Köprü / TBL Series Screw Cross Connection	2	4	50	<b>16,80</b>
8013094133	<b>SCC 4/3 TBL 4 2P</b>	TBL Serisi Vidalı Üst Köprü / TBL Series Screw Cross Connection	3	4	50	<b>24,00</b>
8013094163	<b>SCC 4/6 TBL 4 2P</b>	TBL Serisi Vidalı Üst Köprü / TBL Series Screw Cross Connection	6	4	20	<b>25,90</b>
8013094103	<b>SCC 4/10 TBL 4 2P</b>	TBL Serisi Vidalı Üst Köprü / TBL Series Screw Cross Connection	10	4	10	<b>63,60</b>



TCC 4/3

TCC 4/10

### Tarak Köprüler

#### Comb Connector

Ürün Kodu Product Code	Ürün Adı Product Name	Açıklama Explanation	Pin Pole	Kesit Cross Sec. (mm <sup>2</sup> )	Renk Color	Amb. Mik. Pack. Qty (Adet/Pcs.)	Birim Fiyatı Unit Price (TL/Adet)
8013094323	<b>TCC 4/2</b>	Tarak Köprü Köprü / Comb Connector	2	4	Kırmızı / Red	50	<b>8,50</b>
8013094333	<b>TCC 4/3</b>	Tarak Köprü Köprü / Comb Connector	3	4	Kırmızı / Red	50	<b>12,00</b>
8013094303	<b>TCC 4/10</b>	Tarak Köprü Köprü / Comb Connector	10	4	Kırmızı / Red	10	<b>40,80</b>



SLC 2



SLC-R 4

### Kayar Köprüler

#### Sliding Connector

Ürün Kodu Product Code	Ürün Adı Product Name	Açıklama Explanation	Pin Pole	Kesit Cross Sec. (mm <sup>2</sup> )	Amb. Mik. Pack. Qty (Adet/Pcs.)	Birim Fiyatı Unit Price (TL/Adet)
8013394923	<b>SLC 2</b> ●	TD Serisi Klemensler için Üst Köprü Cross Connection for TD Series	2	6	50	<b>9,80</b>
8013394933	<b>SLC 3</b> ●	TD Serisi Klemensler için Üst Köprü Cross Connection for TD Series	3	6	50	<b>13,20</b>
8013394943	<b>SLC 4</b> ●	TD Serisi Klemensler için Üst Köprü Cross Connection for TD Series	4	6	50	<b>18,60</b>
8014393307	<b>SLC-R 2</b> ●	Test Fişi / Test Plug	2	6	50	<b>25,20</b>
8014393317	<b>SLC-R 3</b> ●	Test Fişi / Test Plug	3	6	50	<b>33,60</b>
8014393327	<b>SLC-R 4</b> ●	Test Fişi / Test Plug	4	6	50	<b>49,20</b>

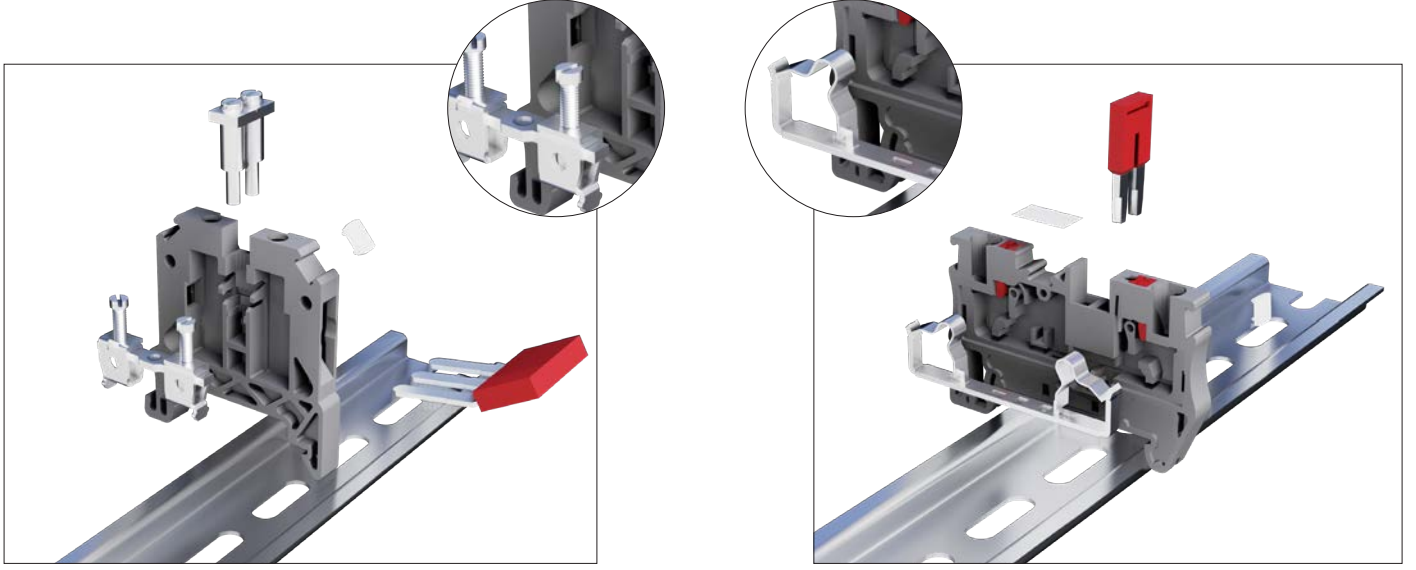

## Vida Bağlantısı

Vidalı bağlantı bilinen en klasik bağlantı yöntemidir. Isıl işlem ile güçlendirilmiş sac ayaklar sayesinde uzun dönemde güvenli ve dayanıklı saha kullanımı mümkündür.

## Güvenilir Bağlantı Ünitesi

Vidalı klemenslerde yer alan bağlantı ünitesi de (klemens ayağı), vidalarda olduğu gibi güçlendirilmiş çelikten üretilmektedir. Vida sıkıldığında bağlantı ünitesinde meydana gelen kuvvet bir kilitleme mekanizması oluşturur. Bu sistem sayesinde, uzun ömürlü ve güvenli bağlantı elde edilmektedir.

## Push-in Bağlantı

Tbloc push-in klemensler, herhangi bir alet kullanmaksızın kolay ve hızlı montaj avantajı sağlamaktadır. Bu bağlantı teknolojisi sayesinde; tek damarlı kablolar ön hazırlığa gerek duymaksızın, çok damarlı kablolar da yüküklü olarak kolayca montajlanabilir. Ayrıca klemens üzerinde yer alan kırmızı butonlar, kullanıcıya klemensin iletken kısımlarına temas etmeden demontaj avantajı sağlamaktadır. Push-in bağlantılı klemensler titreşime karşı dayanıklıdır.

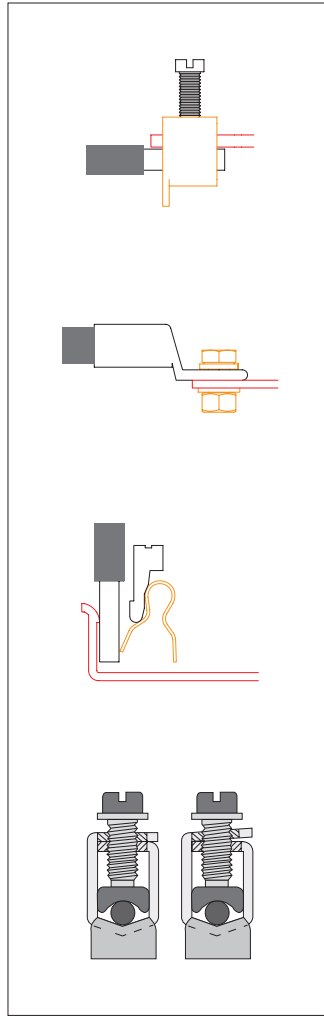

## Screw Connection

Screw type connection is the classical method for terminal blocks. Reinforced clamps ensure the safe and durable connection for long time of usage.

## Reliable Clamping

The connection unit (yokes) in the terminal block is made of reinforced steel, as in the screw. When the screw is tightened, the force that occurs in the connection unit creates a locking mechanism. Thanks to that, durable and safe connection is obtained.

## Push-in Connection

Tbloc push-in terminal blocks provide fast assembly of cables without using a tool. With this technology, solid conductors (just stripping is enough) and flexible conductors (with end ferrules) can be assembled easily. Red buttons on top of the terminal blocks provide easy disassembly without touching conductive parts of the terminal blocks. Push-in connection is resistant to vibration hence can be used safely in many areas.



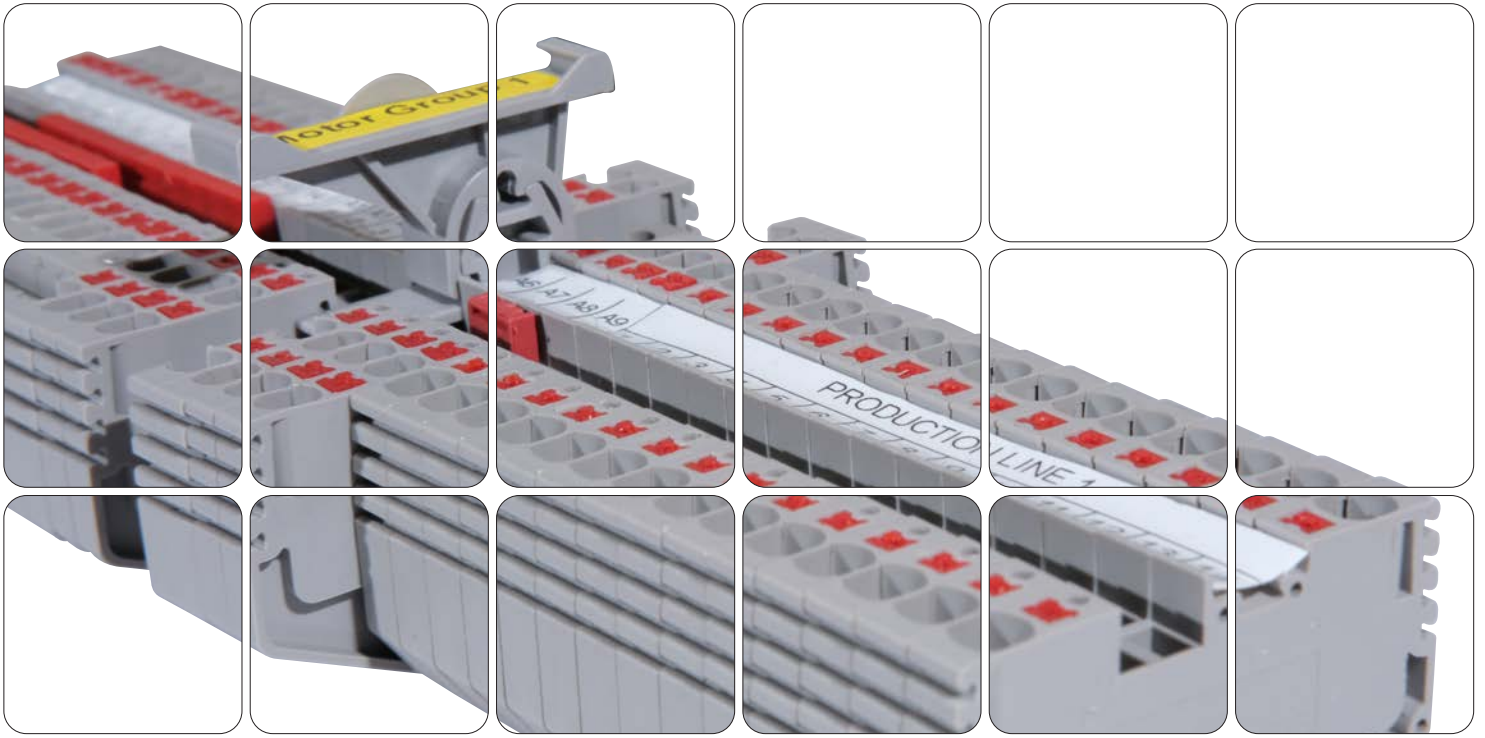

**push-in klemmsler**  
push-in terminal blocks



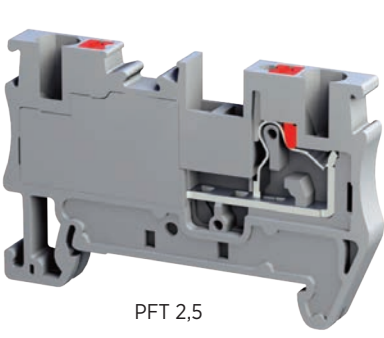

PFT 2,5

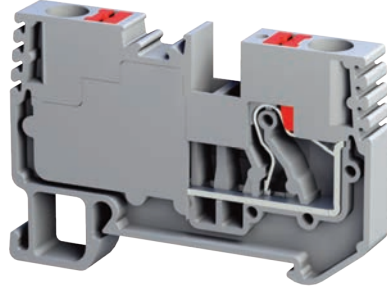

PFT 6



### PFT Serisi Push-in Geçiş Klemensleri

#### PFT Series Push-in Feed Through Terminal Blocks

Ürün Kodu Product Code	Ürün Adı Product Name	Açıklama Explanation	Kesit Cross Sec. (mm <sup>2</sup> )	Renk Color	Amb. Mik. Pack. Qty (Adet/Pcs.)	Koli Mik. Box.Qty. (Adet/Pcs.)	Birim Fiyatı Unit Price (TL/Adet)
8000298008	PFT 2,5	Geçiş Klemensi / Feed Through Terminal	2,5	Gri / Grey	100	1.000	9,00
8000298018	PFT 4	Geçiş Klemensi / Feed Through Terminal	4	Gri / Grey	100	800	12,40
8000298028	PFT 6	Geçiş Klemensi / Feed Through Terminal	6	Gri / Grey	50	500	19,30
8000298038	PFT 10	Geçiş Klemensi / Feed Through Terminal	10	Gri / Grey	30	600	30,80

Renk Kodları / Color Codes

800009900....

...0

...1

...2

...3

...4

...5

...6

...9

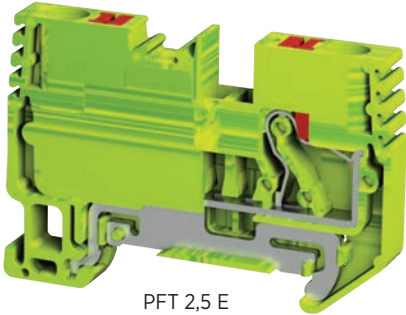

PFT 2,5 E

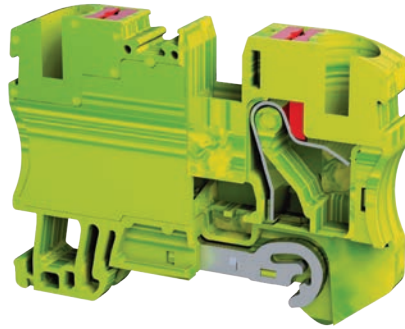

PFT 10 E



### PFT Serisi Push-in Topraklama Klemensleri

#### PFT Series Push-in Earth Terminal Blocks

Ürün Kodu Product Code	Ürün Adı Product Name	Açıklama Explanation	Kesit Cross Sec. (mm <sup>2</sup> )	Renk Color	Amb. Mik. Pack. Qty (Adet/Pcs.)	Koli Mik. Box.Qty. (Adet/Pcs.)	Birim Fiyatı Unit Price (TL/Adet)
8001298064	PFT 2,5 E	Topraklama Klemensi / Earth Terminal	2,5	Sarı-Yeşil / Yellow-Green	50	500	35,50
8001298074	PFT 4 E	Topraklama Klemensi / Earth Terminal	4	Sarı-Yeşil / Yellow-Green	50	500	43,50
8001298084	PFT 6 E	Topraklama Klemensi / Earth Terminal	6	Sarı-Yeşil / Yellow-Green	25	500	59,50
8001298104	PFT 10 E	Topraklama Klemensi / Earth Terminal	10	Sarı-Yeşil / Yellow-Green	30	600	77,00

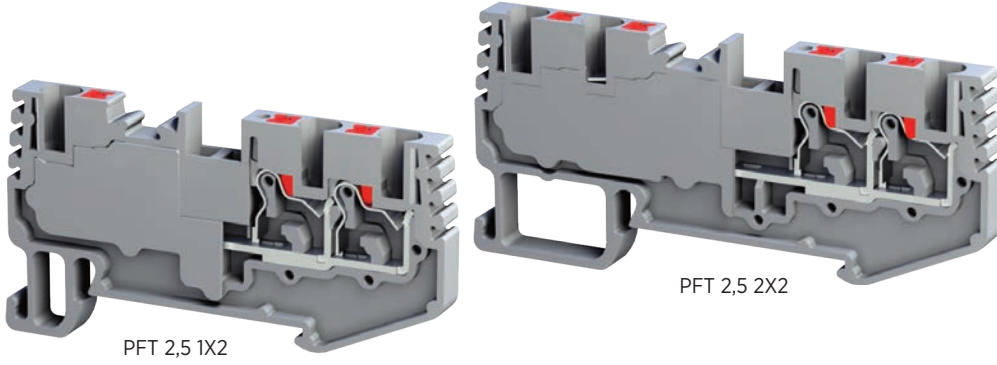

PFT 2,5 1X2

PFT 2,5 2X2

### PFT Serisi Push-in Çok Girişli ve Çıkışlı Klemensler

#### PFT Series Push-in Multilevel Terminal Blocks

Ürün Kodu Product Code	Ürün Adı Product Name	Açıklama Explanation	Kesit Cross Sec. (mm <sup>2</sup> )	Renk Color	Amb. Mik. Pack. Qty (Adet/Pcs.)	Koli Mik. Box.Qty. (Adet/Pcs.)	Birim Fiyatı Unit Price (TL/Adet)
8000298068	<b>PFT 2,5 1X2</b>	1 Giriş 2 Çıkış Geçiş Klemensi 1 Input 2 Output Feed Through Terminal	2,5	Gri / Grey	40	400	<b>19,50</b>
8000298060	<b>PFT 2,5 1X2</b>	1 Giriş 2 Çıkış Geçiş Klemensi 1 Input 2 Output Feed Through Terminal	2,5	Siyah / Black	40	400	<b>19,50</b>
8000298066	<b>PFT 2,5 1X2</b>	1 Giriş 2 Çıkış Geçiş Klemensi 1 Input 2 Output Feed Through Terminal	2,5	Mavi/Blue	40	400	<b>19,50</b>
8000298078	<b>PFT 2,5 2X2</b>	2 Giriş 2 Çıkış Geçiş Klemensi 2 Input 2 Output Feed Through Terminal	2,5	Gri / Grey	40	400	<b>25,30</b>

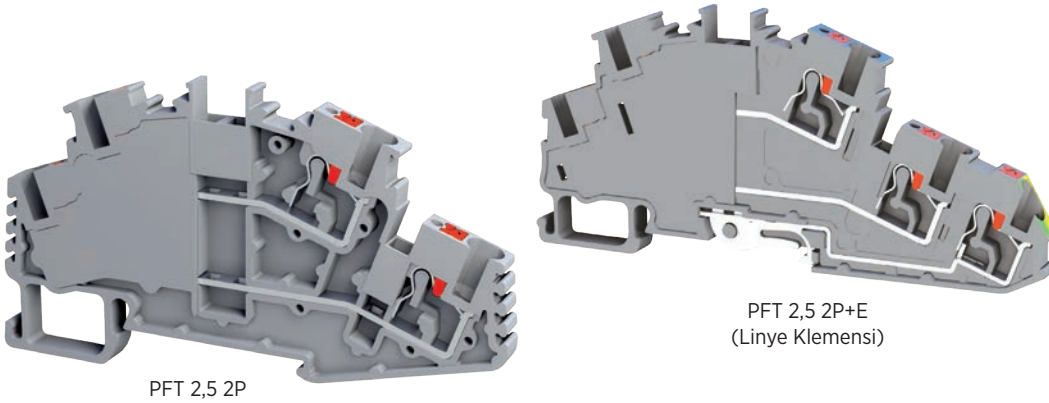

PFT 2,5 2P

PFT 2,5 2P+E  
(Linye Klemensi)

### PFT Serisi Push-in Çok Katlı Klemensler

#### PFT Series Push-in Multilevel Terminal Blocks

Ürün Kodu Product Code	Ürün Adı Product Name	Açıklama Explanation	Kesit Cross Sec. (mm <sup>2</sup> )	Renk Color	Amb. Mik. Pack. Qty (Adet/Pcs.)	Koli Mik. Box.Qty. (Adet/Pcs.)	Birim Fiyatı Unit Price (TL/Adet)
8002298098	<b>PFT 2,5 2P</b>	Çok Katlı Klemens / Multilevel Terminal	2,5	Gri / Grey	50	500	<b>24,50</b>
8002298096	<b>PFT 2,5 2P</b>	Çok Katlı Klemens / Multilevel Terminal	2,5	Mavi/Blue	50	500	<b>24,50</b>
8002298118	<b>PFT 4 2P</b>	Çok Katlı Klemens / Multilevel Terminal	4	Gri / Grey	50	500	<b>35,00</b>
8002298108	<b>PFT 2,5 2P+E</b>	Çok Katlı Klemens + Topraklama Multilevel Terminal + Earth	2,5	Gri / Grey	30	600	<b>70,00</b>



PCC 2,5/2

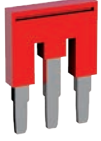

PCC 2,5/3



PCC 4/10

## Üst Köprüler

### Push-in Cross Connections

Ürün Kodu Product Code	Ürün Adı Product Name	Pin Pole	Açıklama Explanation	Kesit Cross Sec. (mm <sup>2</sup> )	Renk Color	Amb. Mik. Pack. Qty (Adet/Pcs.)	Birim Fiyatı Unit Price (TL/Adet)
8013294523	<b>PCC 2,5/2</b>	2	Üst Köprü / Push-in Cross Connections	2,5	Kırmızı / Red	100	<b>8,40</b>
8013294533	<b>PCC 2,5/3</b>	3	Üst Köprü / Push-in Cross Connections	2,5	Kırmızı / Red	100	<b>12,60</b>
8013294503	<b>PCC 2,5/10</b>	10	Üst Köprü / Push-in Cross Connections	2,5	Kırmızı / Red	10	<b>42,00</b>
8013294623	<b>PCC 4/2</b>	2	Üst Köprü / Push-in Cross Connections	4	Kırmızı / Red	100	<b>9,60</b>
8013294633	<b>PCC 4/3</b>	3	Üst Köprü / Push-in Cross Connections	4	Kırmızı / Red	100	<b>14,40</b>
8013294603	<b>PCC 4/10</b>	10	Üst Köprü / Push-in Cross Connections	4	Kırmızı / Red	10	<b>48,00</b>
8013294723	<b>PCC 6/2</b>	2	Üst Köprü / Push-in Cross Connections	6	Kırmızı / Red	50	<b>11,70</b>
8013294733	<b>PCC 6/3</b>	3	Üst Köprü / Push-in Cross Connections	6	Kırmızı / Red	50	<b>17,55</b>
8013294703	<b>PCC 6/10</b>	10	Üst Köprü / Push-in Cross Connections	6	Kırmızı / Red	10	<b>58,50</b>
8013294823	<b>PCC 10/2</b>	2	Üst Köprü / Push-in Cross Connections	10	Kırmızı / Red	10	<b>16,80</b>
8013294833	<b>PCC 10/3</b>	3	Üst Köprü / Push-in Cross Connections	10	Kırmızı / Red	10	<b>25,20</b>

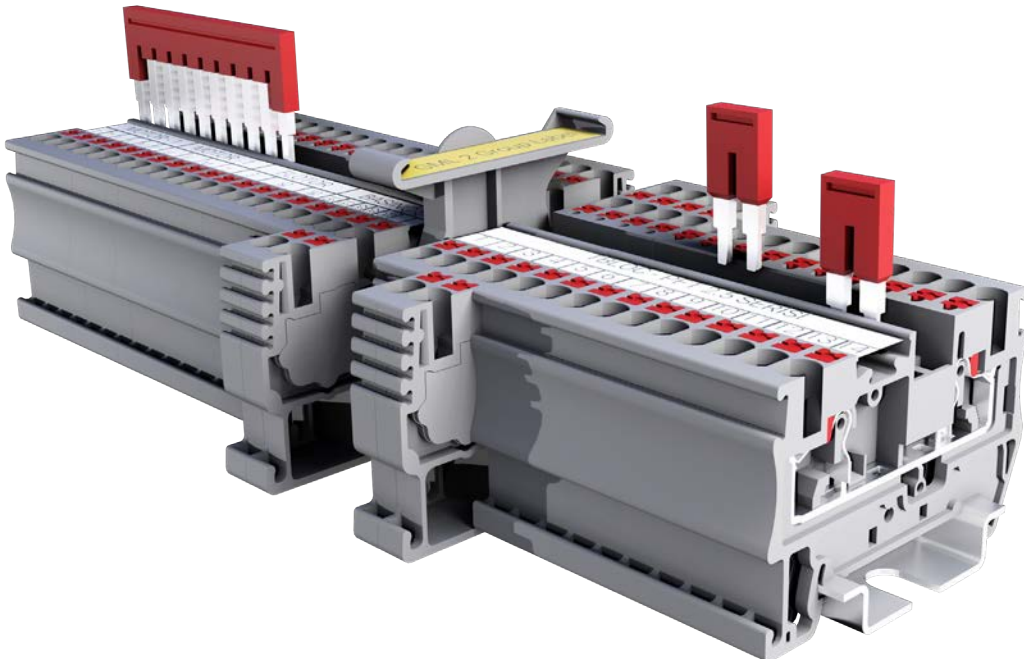



SRK 16/3



SRK 16/8

### Sıra Klemensler

#### Terminal Strips

Ürün Kodu Product Code	Ürün Adı Product Name	Açıklama Explanation	Kutup Sayısı Number of Poles	Renk Color	Amb. Mik. Pack. Qty (Adet/Pcs.)	Birim Fiyatı Unit Price (TL/Adet)
8006097008	<b>SRK 16/2</b>	Sıra Klemens / Terminal Strips	2	Gri / Grey	96	<b>22,00</b>
8006097018	<b>SRK 16/3</b>	Sıra Klemens / Terminal Strips	3	Gri / Grey	32	<b>35,50</b>
8006097028	<b>SRK 16/4</b>	Sıra Klemens / Terminal Strips	4	Gri / Grey	48	<b>42,50</b>
8006097038	<b>SRK 16/5</b>	Sıra Klemens / Terminal Strips	5	Gri / Grey	32	<b>54,00</b>
8006097048	<b>SRK 16/6</b>	Sıra Klemens / Terminal Strips	6	Gri / Grey	30	<b>62,00</b>
8006097058	<b>SRK 16/8</b>	Sıra Klemens / Terminal Strips	8	Gri / Grey	24	<b>83,00</b>
8006097068	<b>SRK 16/10</b>	Sıra Klemens / Terminal Strips	10	Gri / Grey	16	<b>100,00</b>
8006097078	<b>SRK 16/12</b>	Sıra Klemens / Terminal Strips	12	Gri / Grey	8	<b>128,00</b>

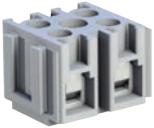

CSK 2,5

### Cihaz Sıra Klemensler

#### Modular Terminal Strips

Ürün Kodu Product Code	Ürün Adı Product Name	Açıklama Explanation	Kesit Cross Sec. (mm <sup>2</sup> )	Renk Color	Amb. Mik. Pack. Qty (Adet/Pcs.)	Birim Fiyatı Unit Price (TL/Adet)
8006097108	<b>CSK 2,5</b>	Cihaz Sıra Klemens / Modular Terminal Strips	2,5	Gri / Grey	100	<b>11,25</b>
8006097118	<b>CSK 6</b>	Cihaz Sıra Klemens / Modular Terminal Strips	6	Gri / Grey	60	<b>18,50</b>

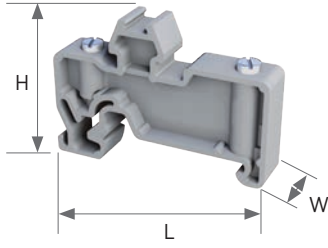

SS 1

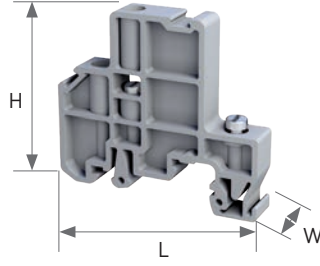

SS 2

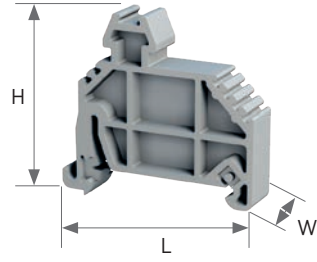

PS 1

### Durdurucu

#### End Bracket

Ürün Kodu Product Code	Ürün Adı Product Name	Açıklama Explanation	Ebatlar Dimension (W/H/L)(mm)	Renk Color	Amb. Mik. Pack. Qty (Adet/Pcs.)	Birim Fiyatı Unit Price (TL/Adet)
8010097308	<b>SS 1</b>	Durdurucu (Vidalı) / End Bracket (Screw)	8/30,7/26,8	Gri / Grey	50	<b>8,60</b>
8010097318	<b>SS 2</b>	Durdurucu (Vidalı) / End Bracket (Screw)	10/50/50,5	Gri / Grey	50	<b>8,90</b>
8010197328	<b>PS 1</b>	Durdurucu (Yaylı) / End Bracket (Spring)	10/42,8/45,6	Gri / Grey	50	<b>8,60</b>

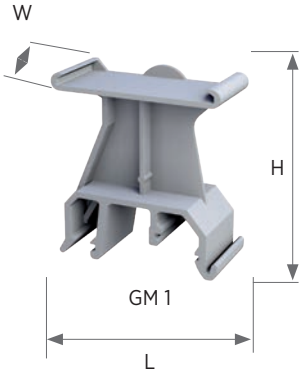

GM 1



GM 2

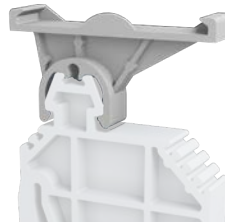

SL 1



LHO

### Grup Etiketi

#### Group Marker

Ürün Kodu Product Code	Ürün Adı Product Name	Açıklama Explanation	Ebatlar Dimension (W/H/L)(mm)	Renk Color	Amb. Mik. Pack. Qty (Adet/Pcs.)	Birim Fiyatı Unit Price (TL/Adet)
8014393008	<b>GM 1</b>	Grup Etiketi / Group Marker	19,5/47/43,7	Gri / Grey	50	<b>11,50</b>
8014393018	<b>GM 2</b>	Grup Etiketi / Group Marker	9,5/47/44,4	Gri / Grey	50	<b>11,00</b>
8012396008	<b>SL 1</b>	Grup Etiketi / Group Marker	9,5/43,7/22,6	Gri / Grey	50	<b>12,00</b>
8020390009	<b>LHO</b>	Şerit Etiket Tutucu / Strip Label Holder	---	Beyaz / White	10	<b>3,20</b>



MTG 5 Baskılı



MTG 5 Baskısız

Ürün Kodu Product Code	Ürün Adı Product Name	Açıklama Description	Plaka Miktarı Plate Qty (Adet/Pcs.)	Amb. Mik. Pack. Qty (Plaka-Plates/Pcs.)	Plaka Fiyatı Plate Price (TL)	Adet Fiyatı Pcs. Price (TL/Adet)
8020389019	MTG 5 Baskılı	Baskılı / Printed	50	500	28,50	0,5700
8020389009	MTG 5 Baskısız	Boş / Empty	50	500	22,00	0,4400
8020389029	MTG 5 (1-10)	1-10	50	500	28,50	0,5700
8020389039	MTG 5 (11-20)	11-20	50	500	28,50	0,5700
8020389049	MTG 5 (21-30)	21-30	50	500	28,50	0,5700
8020389059	MTG 5 (31-40)	31-40	50	500	28,50	0,5700
8020389069	MTG 5 (41-50)	41-50	50	500	28,50	0,5700
8020389079	MTG 5 (51-60)	51-60	50	500	28,50	0,5700
8020389089	MTG 5 (61-70)	61-70	50	500	28,50	0,5700
8020389099	MTG 5 (71-80)	71-80	50	500	28,50	0,5700
8020389109	MTG 5 (81-90)	81-90	50	500	28,50	0,5700
8020389119	MTG 5 (91-100)	91-100	50	500	28,50	0,5700
8020389129	MTG 5 (1-50)	1-50	50	500	28,50	0,5700
8020389139	MTG 5 (51-100)	51-100	50	500	28,50	0,5700
8020389149	MTG 5 (101-150)	101-150	50	500	28,50	0,5700
8020389159	MTG 5 (151-200)	151-200	50	500	28,50	0,5700
8020389169	MTG 5 (201-250)	201-250	50	500	28,50	0,5700
8020389179	MTG 5 (251-300)	251-300	50	500	28,50	0,5700
8020389189	MTG 5 (301-350)	301-350	50	500	28,50	0,5700
8020389199	MTG 5 (351-400)	351-400	50	500	28,50	0,5700
8020389209	MTG 5 (401-450)	401-450	50	500	28,50	0,5700
8020389219	MTG 5 (451-500)	451-500	50	500	28,50	0,5700
8020388019	MTG 6 Baskılı	Baskılı / Printed	50	500	31,00	0,6200
8020388009	MTG 6 Baskısız	Boş / Empty	50	500	25,30	0,5060
8020388839	MTG 6 (L1, L2, L3, N)	L1, L2, L3, N	50	500	31,00	0,6200
8020388309	MTG 6 (0)	0	50	500	31,00	0,6200
8020388319	MTG 6 (1)	1	50	500	31,00	0,6200
8020388599	MTG 6 (5)	5	50	500	31,00	0,6200
8020388329	MTG 6 (2)	2	50	500	31,00	0,6200
8020388339	MTG 6 (3)	3	50	500	31,00	0,6200
8020388349	MTG 6 (4)	4	50	500	31,00	0,6200
8020388359	MTG 6 (5)	5	50	500	31,00	0,6200
8020388369	MTG 6 (6)	6	50	500	31,00	0,6200
8020388379	MTG 6 (7)	7	50	500	31,00	0,6200
8020388389	MTG 6 (8)	8	50	500	31,00	0,6200
8020388399	MTG 6 (9)	9	50	500	31,00	0,6200
8020388409	MTG 6 (10)	10	50	500	31,00	0,6200
8020388029	MTG 6 (0-9)	0-9	50	500	31,00	0,6200
8020388039	MTG 6 (1-10)	1-10	50	500	31,00	0,6200
8020388879	MTG 6 (11-20)	11-20	50	500	31,00	0,6200
8020388889	MTG 6 (21-30)	21-30	50	500	31,00	0,6200
8020388899	MTG 6 (31-40)	31-40	50	500	31,00	0,6200
8020388909	MTG 6 (41-50)	41-50	50	500	31,00	0,6200
8020388919	MTG 6 (51-60)	51-60	50	500	31,00	0,6200
8020388929	MTG 6 (61-70)	61-70	50	500	31,00	0,6200
8020388939	MTG 6 (71-80)	71-80	50	500	31,00	0,6200
8020388949	MTG 6 (81-90)	81-90	50	500	31,00	0,6200
8020388959	MTG 6 (91-100)	91-100	50	500	31,00	0,6200



Ürün Kodu Product Code	Ürün Adı Product Name	Açıklama Description	Plaka Miktarı Plate Qty (Adet/Pcs.)	Amb. Mik. Pack. Qty (Plaka-Plates/Pcs.)	Plaka Fiyatı Plate Price (TL)	Adet Fiyatı Pcs. Price (TL/Adet)
8020388049	MTG 6 (1-50)	1-50	50	500	31,00	0,6200
8020388059	MTG 6 (51-100)	51-100	50	500	31,00	0,6200
8020388069	MTG 6 (101-150)	101-150	50	500	31,00	0,6200
8020388079	MTG 6 (151-200)	151-200	50	500	31,00	0,6200
8020388089	MTG 6 (201-250)	201-250	50	500	31,00	0,6200
8020388099	MTG 6 (251-300)	251-300	50	500	31,00	0,6200
8020388109	MTG 6 (301-350)	301-350	50	500	31,00	0,6200
8020388119	MTG 6 (351-400)	351-400	50	500	31,00	0,6200
8020388129	MTG 6 (401-450)	401-450	50	500	31,00	0,6200
8020388139	MTG 6 (451-500)	451-500	50	500	31,00	0,6200
8020388149	MTG 6 (501-550)	501-550	50	500	31,00	0,6200
8020388159	MTG 6 (551-600)	551-600	50	500	31,00	0,6200
8020388169	MTG 6 (601-650)	601-650	50	500	31,00	0,6200
8020388179	MTG 6 (651-700)	651-700	50	500	31,00	0,6200
8020388189	MTG 6 (701-750)	701-750	50	500	31,00	0,6200
8020388199	MTG 6 (751-800)	751-800	50	500	31,00	0,6200
8020388209	MTG 6 (801-850)	801-850	50	500	31,00	0,6200
8020388219	MTG 6 (851-900)	851-900	50	500	31,00	0,6200
8020388229	MTG 6 (901-950)	901-950	50	500	31,00	0,6200
8020388239	MTG 6 (951-1000)	951-1000	50	500	31,00	0,6200
8020388859	MTG 6 (RSTN)	RSTN	50	500	31,00	0,6200
8020388779	MTG 6 (+)	+	50	500	31,00	0,6200
8020388789	MTG 6 (-)	-	50	500	31,00	0,6200
8020388429	MTG 6 (B)	B	50	500	31,00	0,6200
8020388849	MTG 6 (PE)	PE	50	500	31,00	0,6200
8020388459	MTG 6 (E)	E	50	500	31,00	0,6200
8020388529	MTG 6 (L)	L	50	500	31,00	0,6200
8020388549	MTG 6 (N)	N	50	500	31,00	0,6200
8020388659	MTG 6 (Y)	Y	50	500	31,00	0,6200
8020388589	MTG 6 (R)	R	50	500	31,00	0,6200
8020388829	MTG 6 (L1, L2, L3)	L1, L2, L3	50	500	31,00	0,6200
8020388799	MTG 6 (L1)	L1	50	500	31,00	0,6200
8020388809	MTG 6 (L2)	L2	50	500	31,00	0,6200
8020388499	MTG 6 (I)	I	50	500	31,00	0,6200
8020388449	MTG 6 (D)	D	50	500	31,00	0,6200
8020388519	MTG 6 (K)	K	50	500	31,00	0,6200
8020388469	MTG 6 (F)	F	50	500	31,00	0,6200
8020388419	MTG 6 (A)	A	50	500	31,00	0,6200
8020388539	MTG 6 (M)	M	50	500	31,00	0,6200
8020388569	MTG 6 (P)	P	50	500	31,00	0,6200
8020388679	MTG 6 (X1)	X1	50	500	31,00	0,6200
8020388689	MTG 6 (X2)	X2	50	500	31,00	0,6200
8020388699	MTG 6 (X3)	X3	50	500	31,00	0,6200
8020388709	MTG 6 (X4)	X4	50	500	31,00	0,6200
8020388719	MTG 6 (X5)	X5	50	500	31,00	0,6200
8020388729	MTG 6 (X6)	X6	50	500	31,00	0,6200
8020388739	MTG 6 (X7)	X7	50	500	31,00	0,6200
8020388749	MTG 6 (X8)	X8	50	500	31,00	0,6200



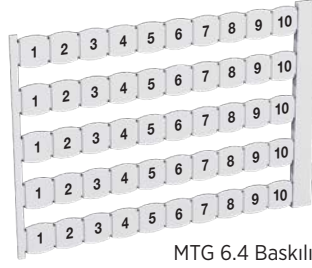

MTG 6.4 Baskılı



MTG 6.4 Baskısız

Ürün Kodu Product Code	Ürün Adı Product Name	Açıklama Description	Plaka Miktarı Plate Qty (Adet/Pcs.)	Amb. Mik. Pack. Qty (Plaka-Plates/Pcs.)	Plaka Fiyatı Plate Price (TL)	Adet Fiyatı Pcs. Price (TL/Adet)
8020388759	MTG 6 (X9)	X9	50	500	31,00	0,6200
8020388769	MTG 6 (X10)	X10	50	500	31,00	0,6200
8020388439	MTG 6 (C)	C	50	500	31,00	0,6200
8020388629	MTG 6 (V)	V	50	500	31,00	0,6200
8020388479	MTG 6 (G)	G	50	500	31,00	0,6200
8020388489	MTG 6 (H)	H	50	500	31,00	0,6200
8020388819	MTG 6 (L3)	L3	50	500	31,00	0,6200
8020388869	MTG 6 (MP)	MP	50	500	31,00	0,6200
8020388609	MTG 6 (T)	T	50	500	31,00	0,6200
8020387019	MTG 6,4 Baskılı	Baskılı / Printed	50	500	33,00	0,6600
8020387009	MTG 6,4 Baskısız	Boş / Empty	50	500	28,50	0,5700
8020387309	MTG 6,4 (1)	1	50	500	33,00	0,6600
8020387319	MTG 6,4 (2)	2	50	500	33,00	0,6600
8020387329	MTG 6,4 (3)	3	50	500	33,00	0,6600
8020387339	MTG 6,4 (4)	4	50	500	33,00	0,6600
8020387349	MTG 6,4 (5)	5	50	500	33,00	0,6600
8020387359	MTG 6,4 (6)	6	50	500	33,00	0,6600
8020387369	MTG 6,4 (7)	7	50	500	33,00	0,6600
8020387379	MTG 6,4 (8)	8	50	500	33,00	0,6600
8020387389	MTG 6,4 (9)	9	50	500	33,00	0,6600
8020387399	MTG 6,4 (10)	10	50	500	33,00	0,6600
8020387029	MTG 6,4 (0-9)	0-9	50	500	33,00	0,6600
8020387039	MTG 6,4 (1-50)	1-50	50	500	33,00	0,6600
8020387049	MTG 6,4 (51-100)	51-100	50	500	33,00	0,6600
8020387059	MTG 6,4 (101-150)	101-150	50	500	33,00	0,6600
8020387069	MTG 6,4 (151-200)	151-200	50	500	33,00	0,6600
8020387079	MTG 6,4 (201-250)	201-250	50	500	33,00	0,6600
8020387089	MTG 6,4 (251-300)	251-300	50	500	33,00	0,6600
8020387099	MTG 6,4 (301-350)	301-350	50	500	33,00	0,6600
8020387109	MTG 6,4 (351-400)	351-400	50	500	33,00	0,6600
8020387119	MTG 6,4 (401-450)	401-450	50	500	33,00	0,6600
8020387129	MTG 6,4 (451-500)	451-500	50	500	33,00	0,6600
8020387139	MTG 6,4 (501-550)	501-550	50	500	33,00	0,6600
8020387149	MTG 6,4 (551-600)	551-600	50	500	33,00	0,6600
8020387159	MTG 6,4 (601-650)	601-650	50	500	33,00	0,6600
8020387169	MTG 6,4 (651-700)	651-700	50	500	33,00	0,6600
8020387179	MTG 6,4 (701-750)	701-750	50	500	33,00	0,6600
8020387189	MTG 6,4 (751-800)	751-800	50	500	33,00	0,6600
8020387199	MTG 6,4 (801-850)	801-850	50	500	33,00	0,6600
8020387209	MTG 6,4 (851-900)	851-900	50	500	33,00	0,6600
8020387219	MTG 6,4 (901-950)	901-950	50	500	33,00	0,6600
8020387229	MTG 6,4 (951-1000)	951-1000	50	500	33,00	0,6600
8020387239	MTG 6,4 (1001-1050)	1001-1050	50	500	33,00	0,6600
8020387249	MTG 6,4 (1051-1100)	1051-1100	50	500	33,00	0,6600
8020386019	MTG 8 Baskılı	Baskılı / Printed	50	500	34,50	0,6900
8020386009	MTG 8 Baskısız	Boş / Empty	50	500	28,50	0,5700
8020386199	MTG 8 (0)	0	50	500	34,50	0,6900
8020386209	MTG 8 (1)	1	50	500	34,50	0,6900

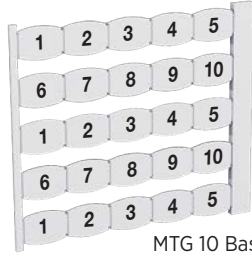

MTG 10 Baskılı

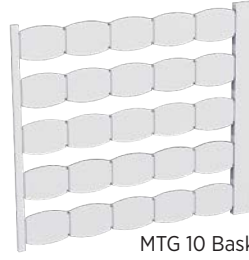

MTG 10 Baskısız

Ürün Kodu Product Code	Ürün Adı Product Name	Açıklama Description	Plaka Miktarı Plate Qty (Adet/Pcs.)	Amb. Mik. Pack. Qty (Plaka-Plates/Pcs.)	Plaka Fiyatı Plate Price (TL)	Adet Fiyatı Pcs. Price (TL/Adet)
8020386219	MTG 8 (2)	2	50	500	34,50	0,6900
8020386229	MTG 8 (3)	3	50	500	34,50	0,6900
8020386239	MTG 8 (4)	4	50	500	34,50	0,6900
8020386249	MTG 8 (5)	5	50	500	34,50	0,6900
8020386259	MTG 8 (6)	6	50	500	34,50	0,6900
8020386269	MTG 8 (7)	7	50	500	34,50	0,6900
8020386279	MTG 8 (8)	8	50	500	34,50	0,6900
8020386289	MTG 8 (9)	9	50	500	34,50	0,6900
8020386299	MTG 8 (10)	10	50	500	34,50	0,6900
8020386309	MTG 8 (0-9)	0-9	50	500	34,50	0,6900
8020386319	MTG 8 (1-10)	1-10	50	500	34,50	0,6900
8020386029	MTG 8 (1-50)	1-50	50	500	34,50	0,6900
8020386039	MTG 8 (51-100)	51-100	50	500	34,50	0,6900
8020386049	MTG 8 (101-150)	101-150	50	500	34,50	0,6900
8020386059	MTG 8 (151-200)	151-200	50	500	34,50	0,6900
8020386069	MTG 8 (201-250)	201-250	50	500	34,50	0,6900
8020386079	MTG 8 (251-300)	251-300	50	500	34,50	0,6900
8020386089	MTG 8 (301-350)	301-350	50	500	34,50	0,6900
8020386099	MTG 8 (351-400)	351-400	50	500	34,50	0,6900
8020386109	MTG 8 (401-450)	401-450	50	500	34,50	0,6900
8020386119	MTG 8 (451-500)	451-500	50	500	34,50	0,6900
8020386169	MTG 8 (701-750)	701-750	50	500	34,50	0,6900
8020386189	MTG 8 (801-850)	801-850	50	500	34,50	0,6900
8020386329	MTG 8 (+)	+	50	500	34,50	0,6900
8020386339	MTG 8 (-)	-	50	500	34,50	0,6900
8020386349	MTG 8 (PE)	PE	50	500	34,50	0,6900
8020386359	MTG 8 (L)	L	50	500	34,50	0,6900
8020386369	MTG 8 (N)	N	50	500	34,50	0,6900
8020386379	MTG 8 (L1, L2, L3)	L1, L2, L3	50	500	34,50	0,6900
8020386389	MTG 8 (L1)	L1	50	500	34,50	0,6900
8020386399	MTG 8 (L2)	L2	50	500	34,50	0,6900
8020386409	MTG 8 (L3)	L3	50	500	34,50	0,6900
8020385019	MTG 10 Baskılı	Baskılı / Printed	25	250	37,00	1,4800
8020385009	MTG 10 Baskısız	Boş / Empty	25	250	30,00	1,2000
8020385029	MTG 10 (1)	1	25	250	37,00	1,4800
8020385039	MTG 10 (2)	2	25	250	37,00	1,4800
8020385049	MTG 10 (3)	3	25	250	37,00	1,4800
8020385059	MTG 10 (4)	4	25	250	37,00	1,4800
8020385069	MTG 10 (5)	5	25	250	37,00	1,4800
8020385079	MTG 10 (6)	6	25	250	37,00	1,4800
8020385089	MTG 10 (7)	7	25	250	37,00	1,4800
8020385099	MTG 10 (8)	8	25	250	37,00	1,4800
8020385109	MTG 10 (9)	9	25	250	37,00	1,4800
8020385119	MTG 10 (10)	10	25	250	37,00	1,4800
8020385129	MTG 10 (RSTN)	RSTN	25	250	37,00	1,4800
8020385139	MTG 10 (L1)	L1	25	250	37,00	1,4800
8020385149	MTG 10 (L2)	L2	25	250	37,00	1,4800
8020385159	MTG 10 (L3)	L3	25	250	37,00	1,4800

# t bloc

## klemens aksesuar seçim tablosu

terminal block accessory selection table

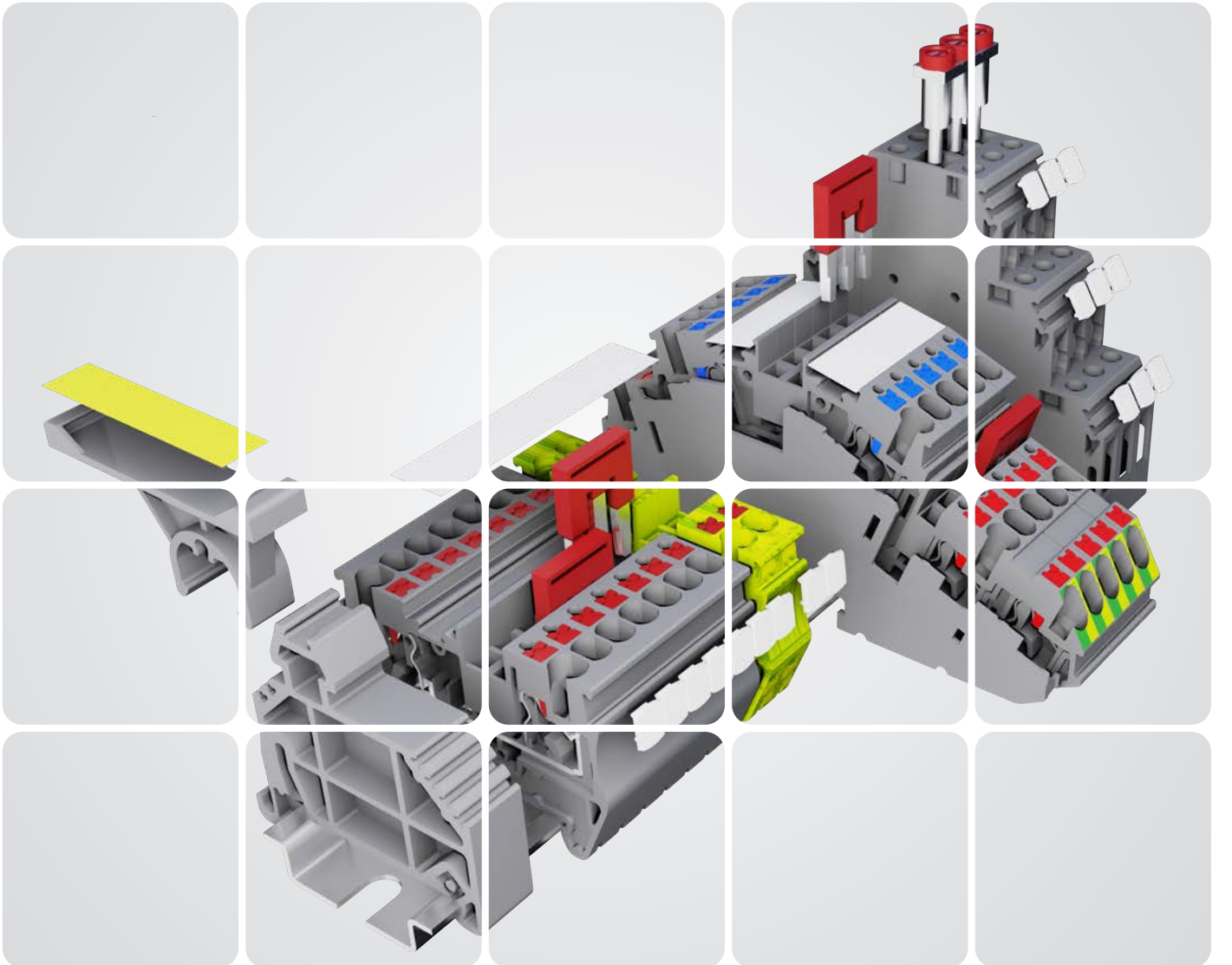

Klemensler Terminals Blocks	Klemens Code List	Nihayet Plakası End Plate	Ayrırma Plakası Separation Plate	Ayrırma Dili Small Partitation Plate	Üst Köprü Cross Connections	Kayar Köprü
TBL 2,5	8000099008	8012396118-EPL TBL 2,5-10	PR TBL 2,5 - 10 8012396408	8012396528 - SPR 2,5-10	8013095023 - SCC 2,5/2 8013095033 - SCC 2,5/3 8013095003 - SCC 2,5/10	---
TBL 4	8000099028	8012396118-EPL TBL 2,5-10	PR TBL 2,5 - 10 8012396408	8012396528 - SPR 2,5-10	SCC 4/2 8013095123 SCC 4/3 8013095133 SCC 4/10 8013095103	---
TBL 6	8000099038	8012396118-EPL TBL 2,5-10	PR TBL 2,5 - 10 8012396408	8012396528 - SPR 2,5-10	8013095223 - SCC 6/2 8013095233 - SCC 6/3 8013095203 - SCC 6/10	---
TBL 10	8000099048	8012396118-EPL TBL 2,5-10	PR TBL 2,5 - 10 8012396408	8012396528 - SPR 2,5-10	8013095323 - SCC 10/2 8013095333 - SCC 10/3 8013095303 - SCC 10/10	---
TBL 16	8000099058	---	8012396568 - GPR	---	8013095423 - SCC 16/2 8013095433 - SCC 16/3 8013095403 - SCC 16/10	---
TBL 25	8000099068	---	8012396568 - GPR	---	8013095523 - SCC 25/2 8013095533 - SCC 25/3 8013095503 - SCC 25/10	---
TBL 35	8000099078	---	8012396568 - GPR	---	8013095623 - SCC 35/2 8013095633 - SCC 35/3 8013095603 - SCC 35/10	---
TBL 50	8000099088	---	8012396568 - GPR	---	SCC 50/2 8013095723 SCC 50 /3 8013095733	---
TBL 70	8000099098	---	8012396568 - GPR	---	SCC 70/2 8013095823 SCC 70 /3 8013095833	---
TBL 95	8000099108	---	---	---	8013095923 - SCC 95/2 8013095933 - SCC 95/3	---
TBL 150	8000099116	---	---	---	SCC 150/2 8013094023	---
NTT 2,5 E	8001099214	8012396118-EPL TBL 2.5-10	---	---	---	---
NTT 4 E	8001099224	8012396118-EPL TBL 2.5-10	---	---	---	---
NTT 6 E	8001099234	8012396118-EPL TBL 2.5-10	---	---	---	---
NTT 10 E	8001099244	8012396118-EPL TBL 2.5-10	---	---	---	---
TBL 16 E	8001099194	---	---	---	---	---
TBL 35 E	8001099204	---	---	---	---	---
TBL 2,5-4 2P	8002099438	8012396208 - EPL TBL 2,5-4 2P	PR TBL 4 2P 8012396508	SPR TBL 4 2P 8012396558	8013095023 - SCC 2,5/2 8013095033 - SCC 2,5/3 8013095003 - SCC 2,5/10	---
TBL 4 2P	8002099258	8012396218-EPL1 TBL 4 2P 8012396228-EPL2 TBL 4 2P 8012396238 - EPL3 TBL 4 2P	8012396568 - GPR	---	8013094103 - SCC 4/10 TBL 4 2P 8013094123 - SCC 4/2 TBL 4 2P 8013094133 - SCC 4/3 TBL 4 2P	---
TBL 2,5-4 2PK	8002099448	8012396208 - EPL TBL 2,5-4 2P	8012396568 - GPR	---	8013094103 - SCC 4/10 TBL 4 2P 8013094123 - SCC 4/2 TBL 4 2P 8013094133 - SCC 4/3 TBL 4 2P	---

Tarak Köprü Comb Connector	Test Fişi Test Socket	Durdurucu Stopper	Şerit Etiket Strip Label	Etiket Marking Tags	Ray DIN Rail	Kapak Cover
---	8014393227 - TST 1	8010097308 - SS 1 8010097318 - SS 2 8010197328 - PS 1	---	8020388009 - MTG 6 Boş	8015393407 - DR 35-7,5 S 2M 8015393427 - DR 35-15 S 2M	---
8013094323 - TCC 4/2 8013094333 - TCC 4/3 8013094303 - TCC 4/10	8014393227 - TST 1	8010097308 - SS 1 8010097318 - SS 2 8010197328 - PS 1	---	8020387009 - MTG 6,4 Boş	8015393407 - DR 35-7,5 S 2M 8015393427 - DR 35-15 S 2M	---
8013394823 - TCC 6/2 8013394833 - TCC 6/3 8013394803 TCC 6/10	8014393108 - TST-I1	8010097308 - SS 1 8010097318 - SS 2 8010197328 - PS 1	---	8020386009 - MTG 8 Boş	8015393407 - DR 35-7,5 S 2M 8015393427 - DR 35-15 S 2M	---
---	8014393108 - TST-I1 8014393237 - TST 2	8010097308 - SS 1 8010097318 - SS 2 8010197328 - PS 1	---	8020385009 - MTG 10 Boş	8015393407 - DR 35-7,5 S 2M 8015393427 - DR 35-15 S 2M	---
---	8014393247 - TST 3	8010097308 - SS 1 8010097318 - SS 2 8010197328 - PS 1	---	8020385009 - MTG 10 Boş	8015393407 - DR 35-7,5 S 2M 8015393427 - DR 35-15 S 2M	---
---	8014393257 - TST 4	8010097308 - SS 1 8010097318 - SS 2 8010197328 - PS 1	---	8020385009 - MTG 10 Boş	8015393407 - DR 35-7,5 S 2M 8015393427 - DR 35-15 S 2M	---
---	8014393257 - TST 4	8010097308 - SS 1 8010097318 - SS 2 8010197328 - PS 1	---	8020385009 - MTG 10 Boş	8015393407 - DR 35-7,5 S 2M 8015393427 - DR 35-15 S 2M	---
---	---	8010097308 - SS 1 8010097318 - SS 2 8010197328 - PS 1	---	8020385009 - MTG 10 Boş	8015393407 - DR 35-7,5 S 2M 8015393427 - DR 35-15 S 2M	---
---	---	8010097308 - SS 1 8010097318 - SS 2 8010197328 - PS 1	---	8020385009 - MTG 10 Boş	8015393407 - DR 35-7,5 S 2M 8015393427 - DR 35-15 S 2M	---
---	---	8010097308 - SS 1 8010097318 - SS 2 8010197328 - PS 1	---	8020385009 - MTG 10 Boş	8015393407 - DR 35-7,5 S 2M 8015393427 - DR 35-15 S 2M	---
---	---	8010097308 - SS 1 8010097318 - SS 2 8010197328 - PS 1	---	8020385009 - MTG 10 Boş	8015393407 - DR 35-7,5 S 2M 8015393427 - DR 35-15 S 2M	---
---	---	---	---	MTG 6 8020388009	8015393407 - DR 35-7,5 S 2M 8015393427 - DR 35-15 S 2M	---
---	---	---	---	MTG 6,4 8020387009	8015393407 - DR 35-7,5 S 2M 8015393427 - DR 35-15 S 2M	---
---	---	---	---	MTG 8 8020386009	8015393407 - DR 35-7,5 S 2M 8015393427 - DR 35-15 S 2M	---
---	---	---	---	MTG 10 8020385009	8015393407 - DR 35-7,5 S 2M 8015393427 - DR 35-15 S 2M	---
---	---	---	---	MTG 10 8020385009	8015393407 - DR 35-7,5 S 2M 8015393427 - DR 35-15 S 2M	---
---	---	---	---	MTG 10 8020385009	8015393407 - DR 35-7,5 S 2M 8015393427 - DR 35-15 S 2M	---
---	8014393227 - TST 1	8010097308 - SS 1 8010097318 - SS 2 8010197328 - PS 1	---	8020388009 - MTG 6 Boş	8015393407 - DR 35-7,5 S 2M 8015393427 - DR 35-15 S 2M	---
---	8014393227 - TST 1	8010097308 - SS 1 8010097318 - SS 2 8010197328 - PS 1	---	8020387009 - MTG 6,4 Boş	8015393407 - DR 35-7,5 S 2M 8015393427 - DR 35-15 S 2M	---
---	8014393227 - TST 1	8010097308 - SS 1 8010097318 - SS 2 8010197328 - PS 1	---	8020388009 - MTG 6 Boş	8015393407 - DR 35-7,5 S 2M 8015393427 - DR 35-15 S 2M	---

Klemensler Terminals Blocks	Klemens Code List	Nihayet Plakası End Plate	Ayırma Plakası Seperation Plate	Ayırma Dili Smal Partitation Plate	Üst Köprü Cross Connections	Kayar Köprü
TBL 2,5-4 2PL (24-48VAC/DC)	8002099458	8012396208 - EPL TBL 2,5-4 2P	8012396568 - GPR	---	---	---
TBL 2,5-4 2PL (110-220VAC/DC)	8002099468	8012396208 - EPL TBL 2,5-4 2P	8012396568 - GPR	---	---	---
TBL 4 2P X1, X2, X3, X4, X5, X6, X7, X8	8002099268 8002099278 8002099288 8002099298 8002099318 8002099305 8002099328 8002099338 8002099348	8012396218 - EPL1 TBL 4 2P 8012396228 - EPL2 TBL 4 2P 8012396238 - EPL3 TBL 4 2P	---	8012396558 - SPR TBL 4 2P	---	---
TBL 4 2PL (24-48VAC/DC)	8002099368	8012396218 - EPL1 TBL 4 2P 8012396228 - EPL2 TBL 4 2P 8012396238 - EPL3 TBL 4 2P	---	8012396558 - SPR TBL 4 2P	---	---
TBL 4 2PL (110-220VAC/DC)	8002099378	8012396218 - EPL1 TBL 4 2P 8012396228 - EPL2 TBL 4 2P 8012396238 - EPL3 TBL 4 2P	---	8012396558 - SPR TBL 4 2P	---	---
TBL 4 2PK	8002099428	8012396218 - EPL1 TBL 4 2P 8012396228 - EPL2 TBL 4 2P 8012396238 - EPL3 TBL 4 2P	---	8012396558 - SPR TBL 4 2P	---	---
TBL 4 3P	8002099478	---	8012396568 - GPR	---	8013094103 - SCC 4/10 TBL 4 2P 8013094123 - SCC 4/2 TBL 4 2P 8013094133 - SCC 4/3 TBL 4 2P	---
TBL 2,5 S	8003099528	---	---	---	---	---
TBL 2,5 CD	8003099538	---	---	---	---	---
TBL 2,5 CF	8003099548	---	---	---	---	---
TBL 2,5 CFL (24-48 VAC/DC)	8003099558	---	---	---	---	---
TBL 2,5 CFL (110-220 VAC/DC)	8003099568	---	---	---	---	---
TBL 2,5 ST	8003099578	---	---	---	---	---
TBL 2,5 CR	8003099588	---	---	---	---	---
TBL 2,5 CR (1K-1w)	8003099598	---	---	---	---	---
TBL 2,5 CR (2K)	8003099608	---	---	---	---	---
TBL 2,5 CR (2,2K-1w)	8003099618	---	---	---	---	---
TBL 2,5 CR (4,3K)	8003099628	---	---	---	---	---
TBL 2,5 CR (4,7K)	8003099638	---	---	---	---	---

Tarak Köprü Comb Connector	Test Fişi Test Socket	Durdurucu Stopper	Şerit Etiket Strip Label	Etiket Marking Tags	Ray DIN Rail	Kapak Cover
---	8014393227 - TST 1	8010097308 - SS 1 8010097318 - SS 2 8010197328 - PS 1	---	8020388009 - MTG 6 Boş	8015393407 - DR 35-7,5 S 2M 8015393427 - DR 35-15 S 2M	---
---	8014393227 - TST 1	8010097308 - SS 1 8010097318 - SS 2 8010197328 - PS 1	---	8020388009 - MTG 6 Boş	8015393407 - DR 35-7,5 S 2M 8015393427 - DR 35-15 S 2M	---
---	8014393227 - TST 1	8010097308 - SS 1 8010097318 - SS 2 8010197328 - PS 1	---	8020387009 - MTG 6,4 Boş	8015393407 - DR 35-7,5 S 2M 8015393427 - DR 35-15 S 2M	---
---	8014393227 - TST 1	8010097308 - SS 1 8010097318 - SS 2 8010197328 - PS 1	---	8020387009 - MTG 6,4 Boş	8015393407 - DR 35-7,5 S 2M 8015393427 - DR 35-15 S 2M	---
---	8014393227 - TST 1	8010097308 - SS 1 8010097318 - SS 2 8010197328 - PS 1	---	8020387009 - MTG 6,4 Boş	8015393407 - DR 35-7,5 S 2M 8015393427 - DR 35-15 S 2M	---
---	8014393227 - TST 1	8010097308 - SS 1 8010097318 - SS 2 8010197328 - PS 1	---	8020387009 - MTG 6,4 Boş	8015393407 - DR 35-7,5 S 2M 8015393427 - DR 35-15 S 2M	---
---	8014393227 - TST 1	8010097308 - SS 1 8010097318 - SS 2 8010197328 - PS 1	---	8020387009 - MTG 6,4 Boş	8015393407 - DR 35-7,5 S 2M 8015393427 - DR 35-15 S 2M	---
---	---	8010097308 - SS 1 8010097318 - SS 2 8010197328 - PS 1	---	8020388009 - MTG 6 Boş	8015393407 - DR 35-7,5 S 2M 8015393427 - DR 35-15 S 2M	---
---	---	8010097308 - SS 1 8010097318 - SS 2 8010197328 - PS 1	---	8020388009 - MTG 6 Boş	8015393407 - DR 35-7,5 S 2M 8015393427 - DR 35-15 S 2M	---
---	---	8010097308 - SS 1 8010097318 - SS 2 8010197328 - PS 1	---	8020388009 - MTG 6 Boş	8015393407 - DR 35-7,5 S 2M 8015393427 - DR 35-15 S 2M	---
---	---	8010097308 - SS 1 8010097318 - SS 2 8010197328 - PS 1	---	8020388009 - MTG 6 Boş	8015393407 - DR 35-7,5 S 2M 8015393427 - DR 35-15 S 2M	---
---	---	8010097308 - SS 1 8010097318 - SS 2 8010197328 - PS 1	---	8020388009 - MTG 6 Boş	8015393407 - DR 35-7,5 S 2M 8015393427 - DR 35-15 S 2M	---
---	---	8010097308 - SS 1 8010097318 - SS 2 8010197328 - PS 1	---	8020388009 - MTG 6 Boş	8015393407 - DR 35-7,5 S 2M 8015393427 - DR 35-15 S 2M	---
---	---	8010097308 - SS 1 8010097318 - SS 2 8010197328 - PS 1	---	8020388009 - MTG 6 Boş	8015393407 - DR 35-7,5 S 2M 8015393427 - DR 35-15 S 2M	---
---	---	8010097308 - SS 1 8010097318 - SS 2 8010197328 - PS 1	---	8020388009 - MTG 6 Boş	8015393407 - DR 35-7,5 S 2M 8015393427 - DR 35-15 S 2M	---
---	---	8010097308 - SS 1 8010097318 - SS 2 8010197328 - PS 1	---	8020388009 - MTG 6 Boş	8015393407 - DR 35-7,5 S 2M 8015393427 - DR 35-15 S 2M	---
---	---	8010097308 - SS 1 8010097318 - SS 2 8010197328 - PS 1	---	8020388009 - MTG 6 Boş	8015393407 - DR 35-7,5 S 2M 8015393427 - DR 35-15 S 2M	---
---	---	8010097308 - SS 1 8010097318 - SS 2 8010197328 - PS 1	---	8020388009 - MTG 6 Boş	8015393407 - DR 35-7,5 S 2M 8015393427 - DR 35-15 S 2M	---
---	---	8010097308 - SS 1 8010097318 - SS 2 8010197328 - PS 1	---	8020388009 - MTG 6 Boş	8015393407 - DR 35-7,5 S 2M 8015393427 - DR 35-15 S 2M	---

Klemensler Terminals Blocks	Klemens Code List	Nihayet Plakası End Plate	Ayrırma Plakası Seperation Plate	Ayrırma Dili Smal Partitation Plate	Üst Köprü Cross Connections	Kayar Köprü
TBL 2,5 CR (10K)	8003099648	---	---	---	---	---
TBL 2,5 CR (2,2K-2w)	8003099658	---	---	---	---	---
TBL 2,5 CR (5K-2w)	8003099668	---	---	---	---	---
TBL 2,5 CF	8003099546	---	---	---	---	---
TBL 2,5 CFL (24-48 VAC/DC)	8003099556	---	---	---	---	---
TBL 2,5 CFL (110-220 VAC/DC)	8003099566	---	---	---	---	---
FDT 4	8003099488	---	---	---	---	---
FDT 4 L (24-48 VAC/DC)	8003099498	---	---	---	---	---
FDT 4 L (110-220 VAC/DC)	8003099508	---	---	---	---	---
FDT 4 L (24-48 VAC/DC)	8003099496	---	---	---	---	---
FDT 4 L (110-220 VAC/DC)	8003099506	---	---	---	---	---
FDT 4 L (110-220 VAC)	8003099518	---	---	---	---	---
TDT-C 6	8004099808	---	---	---	---	8013394923 - SLC2 8013394933 - SLC 3 8013394943 - SLC 4
TDT-V 6	8004099818	---	---	---	---	8013394923 - SLC 2 8013394933 - SLC 3, 8013394943 - SLC 4
TDS-C 6	8004099828	8012396018 - EPL TDS	---	---	---	8013394923 - SLC 2 8013394933 - SLC 3 8013394943 - SLC 4
TDV-C 6	8004099838	8012396028 - EPL TDV	---	---	---	---
TDS-V 6	8004099848	8012396018 - EPL TDS	---	---	---	8013394923 - SLC 2 8013394933 - SLC 3 8013394943 - SLC 4
TDY-C 6	8004099858	8012396038 - EPL TDY	---	---	---	8014393307 - SLC-R 2 8014393317 - SLC-R 3 8014393327 - SLC-R 4
PFT 2,5	8000298008	---	---	---	8013294523 - PCC 2,5/2 8013294533 - PCC 2,5/3 8013294503 - PCC 2,5/10	---
PFT 4	8000298018	---	---	---	PCC 4/2 8013294623 PCC 4/3 8013294633 PCC 4/10 8013294603	---



Tarak Köprü Comb Connector	Test Fişi Test Socket	Durdurucu Stopper	Şerit Etiket Strip Label	Etiket Marking Tags	Ray DIN Rail	Kapak Cover
---	---	8010097308 - SS 1 8010097318 - SS 2 8010197328 - PS 1	---	8020388009 - MTG 6 Boş	8015393407 - DR 35-7,5 S 2M 8015393427 - DR 35-15 S 2M	---
---	---	8010097308 - SS 1 8010097318 - SS 2 8010197328 - PS 1	---	8020388009 - MTG 6 Boş	8015393407 - DR 35-7,5 S 2M 8015393427 - DR 35-15 S 2M	---
---	---	8010097308 - SS 1 8010097318 - SS 2 8010197328 - PS 1	---	8020388009 - MTG 6 Boş	8015393407 - DR 35-7,5 S 2M 8015393427 - DR 35-15 S 2M	---
---	---	8010097308 - SS 1 8010097318 - SS 2 8010197328 - PS 1	---	8020388009 - MTG 6 Boş	8015393407 - DR 35-7,5 S 2M 8015393427 - DR 35-15 S 2M	---
---	---	8010097308 - SS 1 8010097318 - SS 2 8010197328 - PS 1	---	8020388009 - MTG 6 Boş	8015393407 - DR 35-7,5 S 2M 8015393427 - DR 35-15 S 2M	---
---	---	8010097308 - SS 1 8010097318 - SS 2 8010197328 - PS 1	---	8020388009 - MTG 6 Boş	8015393407 - DR 35-7,5 S 2M 8015393427 - DR 35-15 S 2M	---
8013394823 - TCC 6/2 8013394833 - TCC 6/3 8013394803 TCC 6/10	---	8010097308 - SS 1 8010097318 - SS 2 8010197328 - PS 1	---	8020386009 - MTG 8 Boş	8015393407 - DR 35-7,5 S 2M 8015393427 - DR 35-15 S 2M	---
8013394823 - TCC 6/2 8013394833 - TCC 6/3 8013394803 TCC 6/10	---	8010097308 - SS 1 8010097318 - SS 2 8010197328 - PS 1	---	8020386009 - MTG 8 Boş	8015393407 - DR 35-7,5 S 2M 8015393427 - DR 35-15 S 2M	---
8013394823 - TCC 6/2 8013394833 - TCC 6/3 8013394803 TCC 6/10	---	8010097308 - SS 1 8010097318 - SS 2 8010197328 - PS 1	---	8020386009 - MTG 8 Boş	8015393407 - DR 35-7,5 S 2M 8015393427 - DR 35-15 S 2M	---
8013394823 - TCC 6/2 8013394833 - TCC 6/3 8013394803 TCC 6/10	---	8010097308 - SS 1 8010097318 - SS 2 8010197328 - PS 1	---	8020386009 - MTG 8 Boş	8015393407 - DR 35-7,5 S 2M 8015393427 - DR 35-15 S 2M	---
8013394823 - TCC 6/2 8013394833 - TCC 6/3 8013394803 TCC 6/10	---	8010097308 - SS 1 8010097318 - SS 2 8010197328 - PS 1	---	8020386009 - MTG 8 Boş	8015393407 - DR 35-7,5 S 2M 8015393427 - DR 35-15 S 2M	---
8013394823 - TCC 6/2 8013394833 - TCC 6/3 8013394803 TCC 6/10	---	8010097308 - SS 1 8010097318 - SS 2 8010197328 - PS 1	---	8020386009 - MTG 8 Boş	8015393407 - DR 35-7,5 S 2M 8015393427 - DR 35-15 S 2M	---
8013394823 - TCC 6/2 8013394833 - TCC 6/3 8013394803 TCC 6/10	8014393108 - TST-I 1	8010097308 - SS 1 8010097318 - SS 2 8010197328 - PS 1	---	8020386009 - MTG 8 Boş	8015393407 - DR 35-7,5 S 2M 8015393427 - DR 35-15 S 2M	---
8013394823 - TCC 6/2 8013394833 - TCC 6/3 8013394803 TCC 6/10	8014393108 - TST-I 1	8010097308 - SS 1 8010097318 - SS 2 8010197328 - PS 1	---	8020386009 - MTG 8 Boş	8015393407 - DR 35-7,5 S 2M 8015393427 - DR 35-15 S 2M	---
8013394823 - TCC 6/2 8013394833 - TCC 6/3 8013394803 TCC 6/10	8014393108 - TST-I 1	8010097308 - SS 1 8010097318 - SS 2 8010197328 - PS 1	---	8020386009 - MTG 8 Boş	8015393407 - DR 35-7,5 S 2M 8015393427 - DR 35-15 S 2M	---
8013394823 - TCC 6/2 8013394833 - TCC 6/3 8013394803 TCC 6/10	---	8010097308 - SS 1 8010097318 - SS 2 8010197328 - PS 1	---	8020386009 - MTG 8 Boş	8015393407 - DR 35-7,5 S 2M 8015393427 - DR 35-15 S 2M	---
8013394823 - TCC 6/2 8013394833 - TCC 6/3 8013394803 TCC 6/10	8014393108 - TST-I 1	8010097308 - SS 1 8010097318 - SS 2 8010197328 - PS 1	---	8020386009 - MTG 8 Boş	8015393407 - DR 35-7,5 S 2M 8015393427 - DR 35-15 S 2M	---
8013394823 - TCC 6/2 8013394833 - TCC 6/3 8013394803 TCC 6/10	8014393108 - TST-I 1	8010097308 - SS 1 8010097318 - SS 2 8010197328 - PS 1	---	8020386009 - MTG 8 Boş	8015393407 - DR 35-7,5 S 2M 8015393427 - DR 35-15 S 2M	---
---	---	8010097308 - SS 1 8010097318 - SS 2 8010197328 - PS 1	8020384009 - TBSL 22X20	8020389009 - MTG 5 Boş	8015393407 - DR 35-7,5 S 2M 8015393427 - DR 35-15 S 2M	---
---	---	8010097308 - SS 1 8010097318 - SS 2 8010197328 - PS 1	8020384009 - TBSL 22X20	MTG 6 8020388009	8015393407 - DR 35-7,5 S 2M 8015393427 - DR 35-15 S 2M	---

Klemensler Terminals Blocks	Klemens Code List	Nihayet Plakası End Plate	Ayrırma Plakası Seperation Plate	Ayrırma Dili Smal Partitation Plate	Üst Köprü Cross Connections	Kayar Köprü
PFT 6	8000298028	---	---	---	PCC 6/2 8013294723 PCC 6/3 8013294733 PCC 6/10 8013294703	---
PFT 10	8000298038	---	---	---	PCC 10/2 8013294823 PCC 10/3 8013294833	---
PFT 2,5 E	8001298064	---	---	---	---	---
PFT 4 E	8001298074	---	---	---	---	---
PFT 6 E	8001298084	---	---	---	---	---
PFT 10 E	8001298104	---	---	---	PCC 10/2 8013294823 PCC 10/3 8013294833	---
PFT 2,5 1X2	8000298068	---	---	---	8013294523 - PCC 2,5/2 8013294533 - PCC 2,5/3 8013294503 - PCC 2,5/10	---
PFT 2,5 1X2	8000298060	---	---	---	8013294523 - PCC 2,5/2 8013294533 - PCC 2,5/3 8013294503 - PCC 2,5/10	---
PFT 2,5 2X2	8000298078	---	---	---	8013294523 - PCC 2,5/2 8013294533 - PCC 2,5/3 8013294503 - PCC 2,5/10	---
PFT 2,5 2P	8002298098	---	---	---	8013294523 - PCC 2,5/2 8013294533 - PCC 2,5/3 8013294503 - PCC 2,5/10	---
PFT 2,5 2P+E	8002298108	---	---	---	8013294523 - PCC 2,5/2 8013294533 - PCC 2,5/3 8013294503 - PCC 2,5/10	---
PFT 4 2P	8002298118	---	---	---	PCC 4/2 8013294623 PCC 4/3 8013294633 PCC 4/10 8013294603	---
TBB 70	8000099128	---	---	---	---	---
TBB 95	8000099138	---	---	---	---	---
TBB 150	8000099148	---	---	---	---	---
TBB 240	8000099158	---	---	---	---	---

Tarak Köprü Comb Connector	Test Fişi Test Socket	Durdurucu Stopper	Şerit Etiket Strip Label	Etiket Marking Tags	Ray DIN Rail	Kapak Cover
---	---	8010097308 - SS 1 8010097318 - SS 2 8010197328 - PS 1	8020384009 - TBSL 22X20	MTG 8 8020386009	8015393407 - DR 35-7,5 S 2M 8015393427 - DR 35-15 S 2M	---
---	---	8010097308 - SS 1 8010097318 - SS 2 8010197328 - PS 1	8020384009 - TBSL 22X20	MTG 10 8020385009	8015393407 - DR 35-7,5 S 2M 8015393427 - DR 35-15 S 2M	---
---	---	8010097308 - SS 1 8010097318 - SS 2 8010197328 - PS 1	8020384009 - TBSL 22X20	8020389009 - MTG 5 Boş	8015393407 - DR 35-7,5 S 2M 8015393427 - DR 35-15 S 2M	---
---	---	8010097308 - SS 1 8010097318 - SS 2 8010197328 - PS 1	8020384009 - TBSL 22X20	MTG 6 8020388009	8015393407 - DR 35-7,5 S 2M 8015393427 - DR 35-15 S 2M	---
---	---	8010097308 - SS 1 8010097318 - SS 2 8010197328 - PS 1	8020384009 - TBSL 22X20	MTG 8 8020386009	8015393407 - DR 35-7,5 S 2M 8015393427 - DR 35-15 S 2M	---
---	---	8010097308 - SS 1 8010097318 - SS 2 8010197328 - PS 1	8020384009 - TBSL 22X20	MTG 10 8020385009	8015393407 - DR 35-7,5 S 2M 8015393427 - DR 35-15 S 2M	---
---	---	8010097308 - SS 1 8010097318 - SS 2 8010197328 - PS 1	8020384009 - TBSL 22X20	8020389009 - MTG 5 Boş	8015393407 - DR 35-7,5 S 2M 8015393427 - DR 35-15 S 2M	---
---	---	8010097308 - SS 1 8010097318 - SS 2 8010197328 - PS 1	8020384009 - TBSL 22X20	8020389009 - MTG 5 Boş	8015393407 - DR 35-7,5 S 2M 8015393427 - DR 35-15 S 2M	---
---	---	8010097308 - SS 1 8010097318 - SS 2 8010197328 - PS 1	8020384009 - TBSL 22X20	8020389009 - MTG 5 Boş	8015393407 - DR 35-7,5 S 2M 8015393427 - DR 35-15 S 2M	---
---	---	8010097308 - SS 1 8010097318 - SS 2 8010197328 - PS 1	8020384009 - TBSL 22X20	8020389009 - MTG 5 Boş	8015393407 - DR 35-7,5 S 2M 8015393427 - DR 35-15 S 2M	---
---	---	8010097308 - SS 1 8010097318 - SS 2 8010197328 - PS 1	8020384009 - TBSL 22X20	8020389009 - MTG 5 Boş	8015393407 - DR 35-7,5 S 2M 8015393427 - DR 35-15 S 2M	---
---	---	8010097308 - SS 1 8010097318 - SS 2 8010197328 - PS 1	8020384009 - TBSL 22X20	MTG 6 8020388009	8015393407 - DR 35-7,5 S 2M 8015393427 - DR 35-15 S 2M	---
---	---	8010097308 - SS 1 8010097318 - SS 2 8010197328 - PS 1	---	8020389009 - MTG 5 Boş	8015393407 - DR 35-7,5 S 2M 8015393427 - DR 35-15 S 2M	C-TBB 70-95-150
---	---	8010097308 - SS 1 8010097318 - SS 2 8010197328 - PS 1	---	8020389009 - MTG 5 Boş	8015393407 - DR 35-7,5 S 2M 8015393427 - DR 35-15 S 2M	C-TBB 70-95-150
---	---	8010097308 - SS 1 8010097318 - SS 2 8010197328 - PS 1	---	8020389009 - MTG 5 Boş	8015393407 - DR 35-7,5 S 2M 8015393427 - DR 35-15 S 2M	C-TBB 70-95-150
---	---	8010097308 - SS 1 8010097318 - SS 2 8010197328 - PS 1	---	8020389009 - MTG 5 Boş	8015393407 - DR 35-7,5 S 2M 8015393427 - DR 35-15 S 2M	C-TBB 240



Elektrolitik beyaz krom kaplanmış galvaniz çelik malzeme  
Electrolytic white chromated & galvanized steel material  
**EN 50022 EN 50035 IEC 60715**

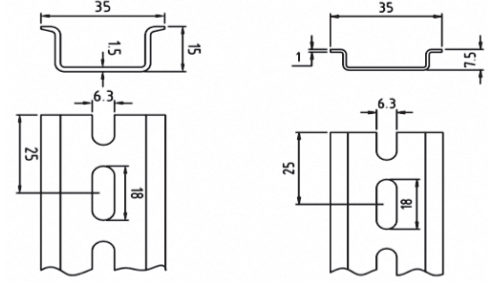

### Montaj Rayları

#### Mounting Rails

Ürün Kodu Product Code	Ürün Adı Product Name	Ölçüler / Dimensions (mm)		Açıklama Explanation	Birim Uzunluk Unit Length (m)	Ambalaj Miktarı Package Qty (metre/meter)	Birim Fiyatı Unit Price (TL/mt.)
		W	H				
8015393407	<b>DR 35-7,5 S 2M</b>	35	7,5	Delikli Din Normu Ray / Slotted Din Rail	2	40	<b>74,00</b>
8015393427	<b>DR 35-15 S 2M</b>	35	15	Delikli Din Normu Ray / Slotted Din Rail	2	20	<b>145,00</b>

### Eko Seri Montaj Rayları

#### Economical Range Mounting Rails

Ürün Kodu Product Code	Ürün Adı Product Name	Ölçüler / Dimensions (mm)		Açıklama Explanation	Birim Uzunluk Unit Length (m)	Ambalaj Miktarı Package Qty (metre/meter)	Birim Fiyatı Unit Price (TL/mt.)
		W	H				
8015393447	<b>DR 35-7,5 E 2M</b>	35	7,5	Delikli Din Normu Ray / Slotted Din Rail	2	40	<b>44,00</b>

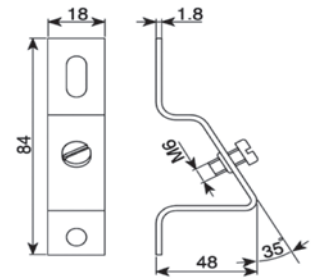

### Ray Taşıyıcılar

#### Rail Supports

Ürün Kodu Product Code	Ürün Adı Product Name	Açıklama Explanation	Delik Çapı Dia. Hole	Ambalaj Miktarı Package Qty (Adet/pcs.)	Birim Fiyatı Unit Price (TL/Adet)
8015393507	<b>ART - M6</b>	35° Açılı Ray Taşıyıcı / 35° Angeled Rail Support	M6	50	<b>11,00</b>



WDC 125

### Kanal Kesme Makası

#### Wiring Duct Cutter

Ürün Kodu Product Code	Ürün Adı Product Name	Açıklama Explanation	Ambalaj Miktarı Package Qty (Adet/pcs.)	Birim Fiyatı Unit Price (TL/Adet)
8019391300	WDC 125	125 mm genişliğe kadar kablo kanalları için Düz kesim tezgah üstü makas. Flat-cut Table-top type cutter up to 120 mm duct width	1	Sorunuz



DRC 2W8R



DRC 1W

### Ray Kesme Makasları

#### Din Rail Cutters

Ürün Kodu Product Code	Ürün Adı Product Name	Açıklama Explanation	Ambalaj Miktarı Package Qty (Adet/pcs.)	Birim Fiyatı Unit Price (TL/Adet)
8015393557	DRC 1W	35x7.5 raya uygun, 1.5 mm kalınlığa kadar kesim, 1 gözlü tezgah üstü makas. 1 way table-top type cutter for 35x7.5 Din Rail, up to 1.5 mm thickness	1	Sorunuz
8015393567	DRC 2W8R	35x7.5, 35x15 raya ve 8 mm Tij kesimine uygun, 3 gözlü tezgah üstü makas. 3 way table-top type cutter for 35x7.5, 35x15 Din Rails and 8 mm Rod	1	Sorunuz

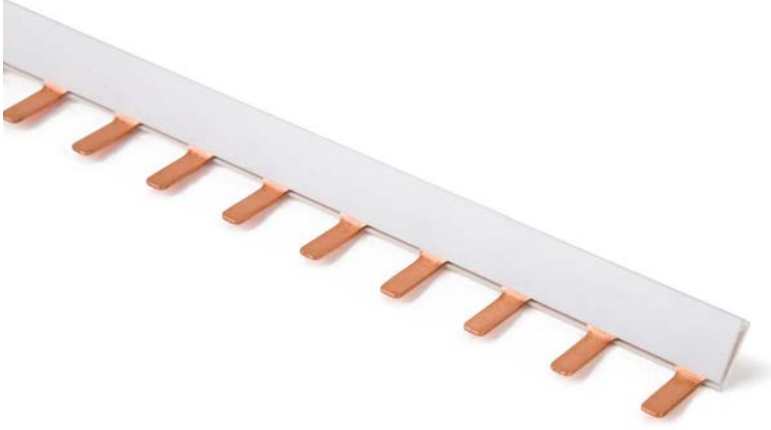

### Monofaze W Otomat Baraları

#### Singlephase MCB Busbars

Ürün Kodu Product Code	Ürün Adı Product Name	Akım Current (A)	Bara Kalınlığı Busbar Thickness (mm)	Uzunluk Length (cm.)	Modül Sayısı Module Number	Ambalaj Mik. Pack. Qty. (TL/Ad.)	Birim Fiyatı Unit Price (TL/Ad.)
8034110010	<b>MJAB80-1x53</b>	80	1	53	30	50	<b>110,00</b>
8034110020	<b>MJAB80-1x106</b>	80	1	106	60	50	<b>220,00</b>
8034110030	<b>MJAB100-1,5x53</b>	100	1.5	53	30	50	<b>195,00</b>
8034110040	<b>MJAB100-1,5x106</b>	100	1.5	106	60	50	<b>390,00</b>

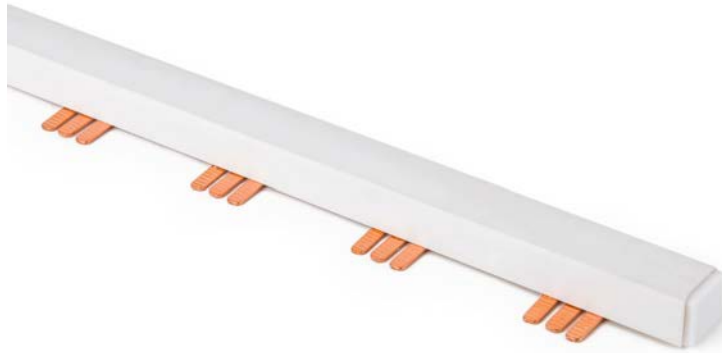

### Trifaze W Otomat Baraları

#### Threephases MCB Busbars

Ürün Kodu Product Code	Ürün Adı Product Name	Akım Current (A)	Bara Kalınlığı Busbar Thickness (mm)	Uzunluk Length (cm.)	Modül Sayısı Module Number	Ambalaj Mik. Pack. Qty. (TL/Ad.)	Birim Fiyatı Unit Price (TL/Ad.)
8034330010	<b>TJAB63- 1x53</b>	63	1	53	10	25	<b>260,00</b>
8034330020	<b>TJAB63- 1x106</b>	63	1	106	20	25	<b>520,00</b>
8034330030	<b>TJAB80- 1x53</b>	80	1	53	10	25	<b>290,00</b>
8034330040	<b>TJAB80- 1x106</b>	80	1	106	20	25	<b>575,00</b>
8034330050	<b>TJAB100-1,5x53</b>	100	1.5	53	10	25	<b>475,00</b>
8034330060	<b>TJAB100-1,5x106</b>	100	1.5	106	20	25	<b>950,00</b>

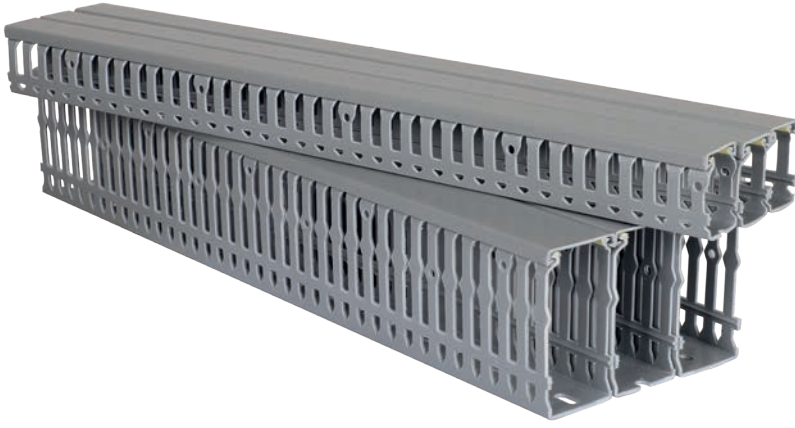

Kendini söndürebilen sert PVC malzeme  
Self-extinguishing rigid PVC material  
EN 50085-1+A  
EN 50085-2-3  
IEC 60695-2-11



### Delikli Kablo Kanalları

#### Slotted Wiring Ducts

Ürün Kodu Product Code	Ürün Adı Product Name	Ölçüler / Dimensions (mm)		Renk Color	Ambalaj Miktarı Package Qty (metre/meter)	Birim Fiyatı Unit Price (TL/mt.)
		W	H			
8019391008	SWD 25X40 Pano Tipi Kablo Kanalı	25	40	Gri / Grey	60	61,00
8019391018	SWD 25X60 Pano Tipi Kablo Kanalı	25	60	Gri / Grey	40	82,00
8019391028	SWD 40X40 Pano Tipi Kablo Kanalı	40	40	Gri / Grey	40	83,00
8019391038	SWD 40X60 Pano Tipi Kablo Kanalı	40	60	Gri / Grey	36	99,00
8019391048	SWD 40X80 Pano Tipi Kablo Kanalı	40	80	Gri / Grey	28	126,00
8019391058	SWD 60X40 Pano Tipi Kablo Kanalı	60	40	Gri / Grey	32	96,00
8019391068	SWD 60X60 Pano Tipi Kablo Kanalı	60	60	Gri / Grey	24	130,00
8019391078	SWD 60X80 Pano Tipi Kablo Kanalı	60	80	Gri / Grey	16	160,00
8019391088	SWD 80X60 Pano Tipi Kablo Kanalı	80	60	Gri / Grey	20	147,00
8019391098	SWD 80X80 Pano Tipi Kablo Kanalı	80	80	Gri / Grey	16	179,00
8019391118	SWD 100X60 Pano Tipi Kablo Kanalı	100	60	Gri / Grey	12	180,00
8019391128	SWD 100X80 Pano Tipi Kablo Kanalı	100	80	Gri / Grey	8	215,00
8019391138	SWD 100X100 Pano Tipi Kablo Kanalı	100	100	Gri / Grey	8	275,00

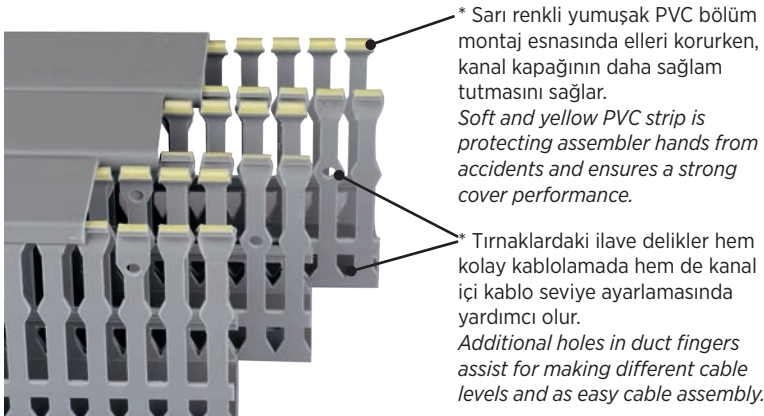

### Kablo Kanal Kapakları

#### Wiring Duct Covers

Ürün Kodu Product Code	Ürün Adı Product Name	En Width (mm.)	Boy Length (m.)	Renk Color	Ambalaj Miktarı Package Qty (metre/meter)	Birim Fiyatı Unit Price (TL/mt.)
8019391208	SWC 25 Kapak	20	2	Gri / Grey	40	18,50
8019391218	SWC 40 Kapak	40	2	Gri / Grey	40	28,00
8019391228	SWC 60 Kapak	60	2	Gri / Grey	40	39,00
8019391238	SWC 80 Kapak	80	2	Gri / Grey	40	55,00
8019391248	SWC 100 Kapak	100	2	Gri / Grey	40	74,00



**Teknik Bilgiler**

Technical Information

Ürün Kodu Product Code	Ürün Adı Product Name	Ölçüler / Dimensions (mm)						Ölçülmüş Toplam Kesit Measured Total Cross Sec. (mm <sup>2</sup> )	İletken Dolum Kapasitesi (%60 oran için) Wire Filling Capacity (for 60% ratio)		
		W	H	E	F	G	Ø		2,5 mm <sup>2</sup>	1,5 mm <sup>2</sup>	1,0 mm <sup>2</sup>
8019391008	<b>SWD 25X40</b>	25	40	6,5	6	12,8	4,5	820	35	51	78
8019391018	<b>SWD 25X60</b>	25	60	6,5	6	15,7	4,5	1.190	57	83	112
8019391028	<b>SWD 40X40</b>	40	40	6,5	6	12,8	4,5	1.360	65	94	129
8019391038	<b>SWD 40X60</b>	40	60	6,5	6	15,7	4,5	2.040	98	141	192
8019391048	<b>SWD 40X80</b>	40	80	6,5	6	19,8	4,5	2.700	130	187	255
8019391058	<b>SWD 60X40</b>	60	40	6,5	6	12,8	4,5	1.970	95	134	188
8019391068	<b>SWD 60X60</b>	60	60	6,5	6	15,7	4,5	3.080	148	214	291
8019391078	<b>SWD 60X80</b>	60	80	6,5	6	19,8	4,5	4.140	200	289	392
8019391088	<b>SWD 80X60</b>	80	60	6,5	6	15,7	4,5	4.150	200	288	391
8019391098	<b>SWD 80X80</b>	80	80	6,5	6	19,8	4,5	5.660	272	393	534
8019391118	<b>SWD 100X60</b>	100	60	6,5	6	15,7	4,5	5.250	254	364	491
8019391128	<b>SWD 100X80</b>	100	80	6,5	6	19,8	4,5	7.606	255	418	702
8019391138	<b>SWD 100X100</b>	100	100	6,5	6	19,8	4,5	8.920	430	619	812

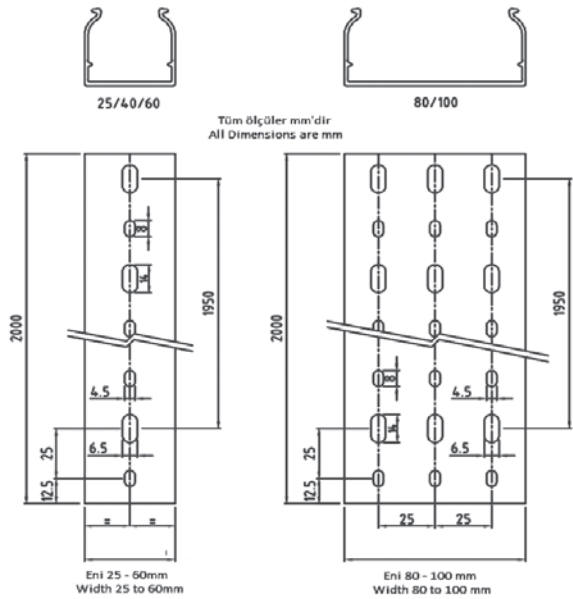
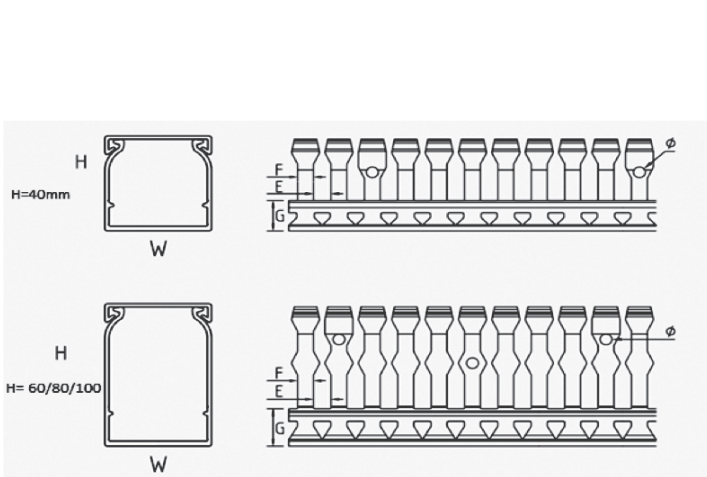

- Kanallar ve kapaklar 2 mt. lik boyda kesilmiş ve paketlenmiştir.
- *Wiring ducts and covers are cut and packed in 2 m length.*





### Termal Transfer Yazıcı

#### Thermal Transfer Printer

Ürün Kodu Product Code	Ürün Adı Product Name	Amb. Mik. Pack. Qty. (Ad./Pcs.)	Birim Fiyatı Unit Price (TL/Adet)
8030129000	TBL TP2 Termal Yazıcı / Thermal Printer	1	Sorunuz



### Ribonlar

#### Ribbons

Ürün Kodu Product Code	Ürün Adı Product Name	İç Çap Inner Diameter (mm)	Ölçüler Dimensions (mmxm)	Renk Color	Amb. Mik. Pack. Qty. (Ad./Pcs.)	Birim Fiyatı Unit Price (TL/Adet)
8030129110	RR Ribbon 55x90	12,7 (½ inch)	55x90	Siyah / Black	1	870,00
8030129120	RR Ribbon 50x300	25,4 (1 inch)	50x300	Siyah / Black	1	1.550,00
8030129130	RR Ribbon 110x300	25,4 (1 inch)	110x300	Siyah / Black	1	3.450,00



### Klemensler için Şerit Etiket

#### Terminal Blocks Strip Label

Ürün Kodu Product Code	Ürün Adı Product Name	Ölçüler Dimensions (mmxm)	Renk Color	Rulo Etiket Adedi Labels per Roll	Amb. Mik. Pack. Qty. (Ad./Pcs.)	Birim Fiyatı Unit Price (TL/Adet)
8020384009	TBSL 22X20	22x20	Beyaz White	2 adet Şerit Etiket 2 pcs. of Strip Label	1	770,00
8020384011	TBSL 5,15x5	25,75x20	Beyaz White	5 adet Şerit Etiket 5 pcs. of Strip Label	1	770,00



TBSL 22X20



### Kablo İşaretleme Plakaları (Şeffaf Tüpler için)

#### Cable Marking Plates (for Transparent Sleeves)



TSL 10x4  
ön yüz  
front side

TSL 10x4  
arka yüz  
back side

Ürün Kodu Product Code	Ürün Adı Product Name	Yazım Alanı Print Area (mm)	Açıklama Explanation	Amb. Mik. Pack. Qty. (Ad./Pcs.)	Birim Fiyatı Unit Price (TL/Rulo)	Adet Fiyatı Pcs. Price (TL/Ad.)
8021340004	<b>TSL 10x4</b> Sarı - Beyaz / Yellow - White	10 x 4	Katlamalı Folded	3.000	<b>3.800,00</b>	<b>1,27</b>
8021340104	<b>TSL 12x4</b> Sarı - Beyaz / Yellow - White	12 x 4	Katlamalı Folded	3.000	<b>4.000,00</b>	<b>1,33</b>
8021340014	<b>TSL 15x4</b> Sarı - Beyaz / Yellow - White	15 x 4	Katlamalı Folded	3.000	<b>3.600,00</b>	<b>1,20</b>
8021340024	<b>TSL 23x4</b> Sarı - Beyaz / Yellow - White	23 x 4	Katlamalı Folded	3.000	<b>4.500,00</b>	<b>1,50</b>
8021340034	<b>TSL 30x4</b> Sarı - Beyaz / Yellow - White	30 x 4	Katlamalı Folded	3.000	<b>5.900,00</b>	<b>1,97</b>

### Şeffaf Tüpler

#### Transparent Sleeves - Closed / Insertion Type



TS 10 1,5-2,5



TS 10 2,5-4,0



TS 10 6,0-10



TS 10 16-25

Ürün Kodu Product Code	Ürün Adı Product Name	Uzunluk Length (mm)	Renk Color	İletken Kesit Cond. Cross Sec. (mm <sup>2</sup> )	Amb. Mik. Pack. Qty. (Ad./Pcs.)	Birim Fiyatı Unit Price (TL/Kutu)	Adet Fiyatı Pcs. Price (TL/Ad.)
8021343019	<b>TS 10 1,5-2,5</b>	10	Şeffaf / Transparent	1,5 - 2,5	500	<b>350,00</b>	<b>0,70</b>
8021343029	<b>TS 12 1,5-2,5</b>	12	Şeffaf / Transparent	1,5 - 2,5	500	<b>490,00</b>	<b>0,98</b>
8021343039	<b>TS 15 1,5-2,5</b>	15	Şeffaf / Transparent	1,5 - 2,5	500	<b>490,00</b>	<b>0,98</b>
8021343049	<b>TS 20 1,5-2,5</b>	20	Şeffaf / Transparent	1,5 - 2,5	500	<b>680,00</b>	<b>1,36</b>
8021343059	<b>TS 30 1,5-2,5</b>	30	Şeffaf / Transparent	1,5 - 2,5	500	<b>1.300,00</b>	<b>2,60</b>
8021344019	<b>TS 10 2,5-4,0</b>	10	Şeffaf / Transparent	2,5 - 4	500	<b>460,00</b>	<b>0,92</b>
8021344029	<b>TS 12 2,5-4,0</b>	12	Şeffaf / Transparent	2,5 - 4	500	<b>560,00</b>	<b>1,12</b>
8021344039	<b>TS 15 2,5-4,0</b>	15	Şeffaf / Transparent	2,5 - 4	500	<b>640,00</b>	<b>1,28</b>
8021344049	<b>TS 20 2,5-4,0</b>	20	Şeffaf / Transparent	2,5 - 4	500	<b>710,00</b>	<b>1,42</b>
8021344059	<b>TS 30 2,5-4,0</b>	30	Şeffaf / Transparent	2,5 - 4	500	<b>1.375,00</b>	<b>2,75</b>
8021345019	<b>TS 10 6,0-10</b>	10	Şeffaf / Transparent	6 - 10	500	<b>520,00</b>	<b>1,04</b>
8021345029	<b>TS 12 6,0-10</b>	12	Şeffaf / Transparent	6 - 10	500	<b>640,00</b>	<b>1,28</b>
8021345039	<b>TS 15 6,0-10</b>	15	Şeffaf / Transparent	6 - 10	500	<b>670,00</b>	<b>1,34</b>
8021345049	<b>TS 20 6,0-10</b>	20	Şeffaf / Transparent	6 - 10	500	<b>930,00</b>	<b>1,86</b>
8021345059	<b>TS 30 6,0-10</b>	30	Şeffaf / Transparent	6 - 10	500	<b>1.500,00</b>	<b>3,00</b>
8021346019	<b>TS 10 16-25</b>	10	Şeffaf / Transparent	16 - 25	500	<b>670,00</b>	<b>1,34</b>
8021346029	<b>TS 12 16-25</b>	12	Şeffaf / Transparent	16 - 25	500	<b>810,00</b>	<b>1,62</b>
8021346039	<b>TS 15 16-25</b>	15	Şeffaf / Transparent	16 - 25	500	<b>920,00</b>	<b>1,84</b>
8021346049	<b>TS 20 16-25</b>	20	Şeffaf / Transparent	16 - 25	200	<b>485,00</b>	<b>2,43</b>
8021346059	<b>TS 30 16-25</b>	30	Şeffaf / Transparent	16 - 25	200	<b>785,00</b>	<b>3,93</b>

### İnce Yapışkanlı Etiketler (Pano Yüzeyi, Kontaktör ve Pano İçi Diğer Cihazlar için)

Slim Adhesive Labels (For Panel Surface, Contactors and Other Devices Inside Panel)

Ürün Kodu Product Code	Ürün Adı Product Name	Yazım Alanı Print Area (mm)	Renk Color	Amb. Mik. Pack. Qty. (Ad./Pcs.)	Birim Fiyatı Unit Price (TL/Rulo)	Adet Fiyatı Pcs. Price (TL/Ad.)
8022120004	SPEL 12x9	12x9	Sarı / Yellow	2.500	750,00	0,30
8022120008	SPEL 12x9	12x9	Gümüş / Silver	2.500	750,00	0,30
8022120009	SPEL 12x9	12x9	Beyaz / White	2.500	750,00	0,30
8022120014	SPEL 15x6	15x6	Sarı / Yellow	2.500	770,00	0,31
8022120018	SPEL 15x6	15x6	Gümüş / Silver	2.500	770,00	0,31
8022120019	SPEL 15x6	15x6	Beyaz / White	2.500	770,00	0,31
8022120024	SPEL 15x9	15x9	Sarı / Yellow	2.500	1.150,00	0,46
8022120028	SPEL 15x9	15x9	Gümüş / Silver	2.500	1.150,00	0,46
8022120029	SPEL 15x9	15x9	Beyaz / White	2.500	1.150,00	0,46
8022120034	SPEL 17x10	17x10	Sarı / Yellow	2.500	1.150,00	0,46
8022120038	SPEL 17x10	17x10	Gümüş / Silver	2.500	1.150,00	0,46
8022120039	SPEL 17x10	17x10	Beyaz / White	2.500	1.150,00	0,46
8022120044	SPEL 18x8	18x8	Sarı / Yellow	2.500	1.190,00	0,48
8022120048	SPEL 18x8	18x8	Gümüş / Silver	2.500	1.190,00	0,48
8022120049	SPEL 18x8	18x8	Beyaz / White	2.500	1.190,00	0,48
8022120054	SPEL 27x12,5	27x12	Sarı / Yellow	2.500	2.400,00	0,96
8022120058	SPEL 27x12,5	27x12	Gümüş / Silver	2.500	2.400,00	0,96
8022120059	SPEL 27x12,5	27x12	Beyaz / White	2.500	2.400,00	0,96
8022120064	SPEL 27x15	27x15	Sarı / Yellow	2.500	2.550,00	1,02
8022120068	SPEL 27x15	27x15	Gümüş / Silver	2.500	2.550,00	1,02
8022120069	SPEL 27x15	27x15	Beyaz / White	2.500	2.550,00	1,02
8022120074	SPEL 27x18	27x18	Sarı / Yellow	2.500	2.750,00	1,10
8022120078	SPEL 27x18	27x18	Gümüş / Silver	2.500	2.750,00	1,10
8022120079	SPEL 27x18	27x18	Beyaz / White	2.500	2.750,00	1,10
8022120098	SPEL 35x18	35x18	Gümüş / Silver	1.500	1.880,00	1,25
8022120108	SPEL 45x15	45x15	Gümüş / Silver	2.000	2.600,00	1,30
8022120118	SPEL 70x30	70x30	Gümüş / Silver	250	1.350,00	5,40
8022120128	SPEL 90x40	90x40	Gümüş / Silver	250	1.450,00	5,80
8022120138	SPEL 100x50	100x50	Gümüş / Silver	250	1.570,00	6,28



SPEL 27x15



SPEL 35x15



SPEL 15x6

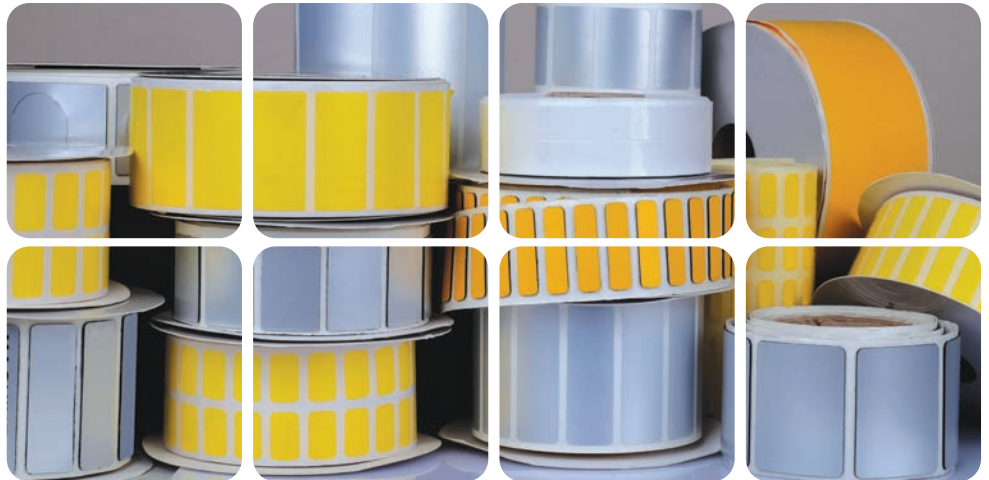

**Kalın Yapışkanlı Etiketler (Pano Yüzeyi için)**

Thick Adhesive Labels (For Panel Surface)



TPEL 40x30



TPEL 60x15

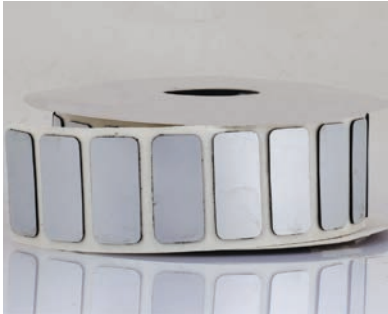

TPEL 45x15

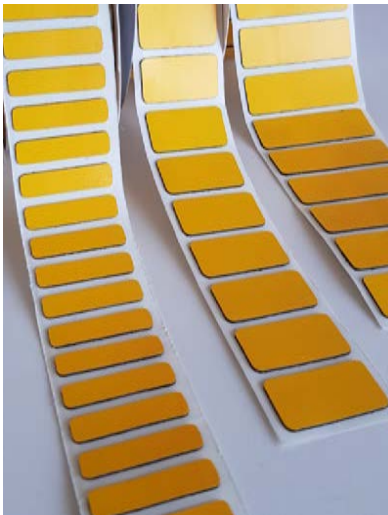

Ürün Kodu Product Code	Ürün Adı Product Name	Yazım Alanı Print Area (mm)	Renk Color	Amb. Mik. Pack. Qty. (Ad./Pcs.)	Birim Fiyatı Unit Price (TL/Rulo)	Adet Fiyatı Pcs. Price (TL/Ad.)
8022130014	TPEL 22x22	22x22	Sarı / Yellow	150	1.850,00	12,33
8022130018	TPEL 22x22	22x22	Gümüş / Silver	150	1.850,00	12,33
8022130019	TPEL 22x22	22x22	Beyaz / White	150	1.850,00	12,33
8022130004	TPEL 27x12,5	27x12	Sarı / Yellow	150	1.300,00	8,67
8022130008	TPEL 27x12,5	27x12	Gümüş / Silver	150	1.300,00	8,67
8022130009	TPEL 27x12,5	27x12	Beyaz / White	150	1.300,00	8,67
8022130024	TPEL 27x15	27x15	Sarı / Yellow	150	1.500,00	10,00
8022130028	TPEL 27x15	27x15	Gümüş / Silver	150	1.500,00	10,00
8022130029	TPEL 27x15	27x15	Beyaz / White	150	1.500,00	10,00
8022130109	TPEL 27x18	27x18	Beyaz / White	150	1.500,00	10,00
8022130108	TPEL 27x18	27x18	Gümüş / Silver	150	1.500,00	10,00
8022130104	TPEL 27x18	27x18	Sarı / Yellow	150	1.500,00	10,00
8022130034	TPEL 27x27	27x27	Sarı / Yellow	150	2.100,00	14,00
8022130038	TPEL 27x27	27x27	Gümüş / Silver	150	2.100,00	14,00
8022130039	TPEL 27x27	27x27	Beyaz / White	150	2.100,00	14,00
8022130044	TPEL 35x18	35x18	Sarı / Yellow	150	2.250,00	15,00
8022130048	TPEL 35x18	35x18	Gümüş / Silver	150	2.250,00	15,00
8022130049	TPEL 35x18	35x18	Beyaz / White	150	2.250,00	15,00
8022130054	TPEL 40x30	40x30	Sarı / Yellow	125	3.100,00	24,80
8022130058	TPEL 40x30	40x30	Gümüş / Silver	125	3.100,00	24,80
8022130059	TPEL 40x30	40x30	Beyaz / White	125	3.100,00	24,80
8022130064	TPEL 45x15	45x15	Sarı / Yellow	150	2.900,00	19,33
8022130068	TPEL 45x15	45x15	Gümüş / Silver	150	2.900,00	19,33
8022130069	TPEL 45x15	45x15	Beyaz / White	150	2.900,00	19,33
8022130074	TPEL 60x15	60x15	Sarı / Yellow	150	3.500,00	23,33
8022130078	TPEL 60x15	60x15	Gümüş / Silver	150	3.500,00	23,33
8022130079	TPEL 60x15	60x15	Beyaz / White	150	3.500,00	23,33
8022130084	TPEL 60x30	60x30	Sarı / Yellow	125	3.900,00	31,20
8022130088	TPEL 60x30	60x30	Gümüş / Silver	125	3.900,00	31,20
8022130089	TPEL 60x30	60x30	Beyaz / White	125	3.900,00	31,20
8022130094	TPEL 90x45	90x45	Sarı / Yellow	50	2.470,00	49,40
8022130098	TPEL 90x45	90x45	Gümüş / Silver	50	2.470,00	49,40
8022130099	TPEL 90x45	90x45	Beyaz / White	50	2.470,00	49,40



### Buton Etiketleri (22 mm Çapa Uygun)

Push Button Labels (Suitable for 22 mm Diameter)



TPBL 30x40

Ürün Kodu Product Code	Ürün Adı Product Name	Yazım Alanı Print Area (mm)	Renk Color	Delik Çapı Hole Dia. (mm)	Amb. Mik. Pack. Qty. (Ad./Pcs.)	Birim Fiyatı Unit Price (TL/Rulo)	Adet Fiyatı Pcs. Price (TL/Ad.)
8022130114	TPBL 30x40	30 x 13	Sarı / Yellow	23,5	100	2.000,00	20,00
8022130118	TPBL 30x40	30 x 13	Gümüş / Silver	23,5	100	2.000,00	20,00
8022130119	TPBL 30x40	30 x 13	Beyaz / White	23,5	100	2.000,00	20,00



TPBL 30x40

### Buton Etiket Tutucular (22 mm Çapa Uygun)

Push Button Labels (Suitable for 22 mm Diameter)



TBET 50X30 TBET 40X30

Ürün Kodu Product Code	Ürün Adı Product Name	Yazım Alanı Print Area (mm)	Renk Color	Amb. Mik. Pack. Qty. (Ad./Pcs.)	Birim Fiyatı Unit Price (TL/Amb.)	Adet Fiyatı Pcs. Price (TL/Ad.)
8022130330	TBET 40X30	25 x 8	Siyah / Black	60	455,00	7,58
8022130340	TBET 50X30	25 x 18	Siyah / Black	60	460,00	7,67

Boş yazım kağıtları paketin içerisinde.

### Yapışkanlı Pano Etiket Tutucular

Self Adhesive Panel Labels Holders



TYPET 17x75



TYPET 17x50



TYPET 17x30

Ürün Kodu Product Code	Ürün Adı Product Name	Yazım Alanı Print Area (mm)	Renk Color	Amb. Mik. Pack. Qty. (Ad./Pcs.)	Birim Fiyatı Unit Price (TL/Amb.)	Adet Fiyatı Pcs. Price (TL/Ad.)
8022130300	TYPET 17x30	27 x 14	Siyah / Black	100	600,00	6,00
8022130310	TYPET 17x50	49 x 15	Siyah / Black	50	350,00	7,00
8022130320	TYPET 17x75	72 x 15	Siyah / Black	25	200,00	8,00

Boş yazım kağıtları paketin içerisinde.

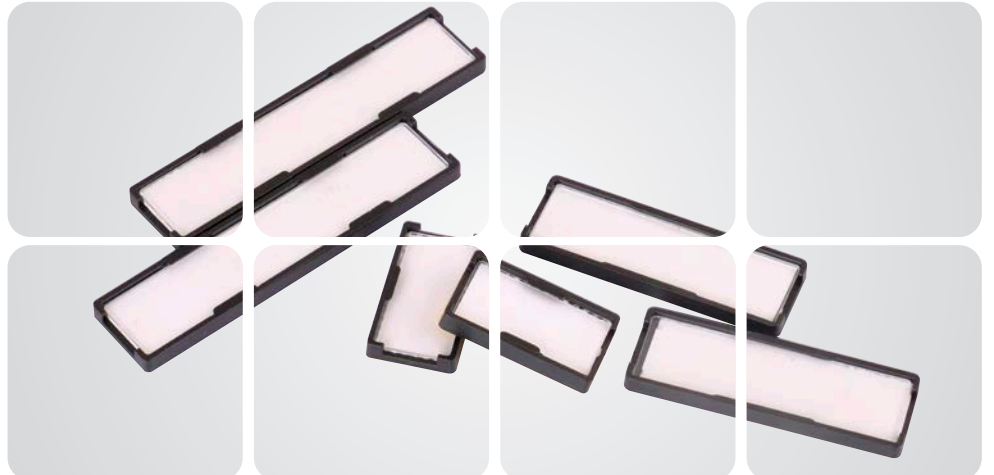

**Klemens Grup Etiketleri için Etiketler**

Labels for Terminal Blocks Group Markers

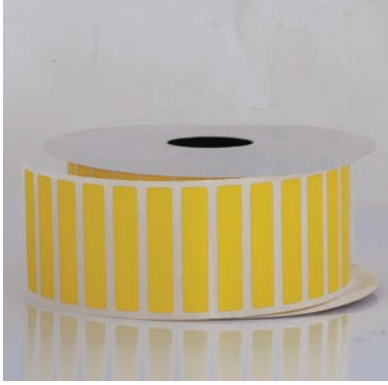

GML 2 36x7

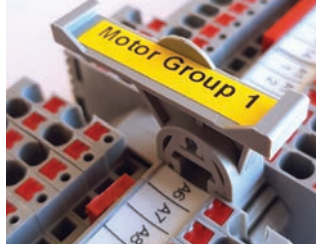

Ürün Kodu Product Code	Ürün Adı Product Name	Yazım Alanı Print Area (mm)	Renk Color	Uyumlu Ürün Explanation	Amb. Mik. Pack. Qty. (Ad./Pcs.)	Birim Fiyatı Unit Price (TL/Rulo)	Adet Fiyatı Pcs. Price (TL/Ad.)
8022130124	<b>GML 1 36x17</b>	36 x 17	Sarı / Yellow	GM 1	2.000	<b>2.200,00</b>	<b>1,10</b>
8022130134	<b>GML 2 36x7</b>	36 x 7	Sarı / Yellow	GM 2	2.000	<b>1.890,00</b>	<b>0,95</b>

**Yapışkanlı Bant Etiketler**

Self Adhesive Endless Labels



SALT 5x20

Ürün Kodu Product Code	Ürün Adı Product Name	Ölçüler Dimensions (mmxm)	Renk Color	Amb. Mik. Pack. Qty. (Ad./Pcs.)	Birim Fiyatı Unit Price (TL/Rulo)
8022130144	<b>SALT 5x50</b>	50 x 50	Sarı / Yellow	1	<b>1.210,00</b>
8022130128	<b>SALT 5x50</b>	50 x 50	Gümüş / Silver	1	<b>1.210,00</b>
8022130129	<b>SALT 5x50</b>	50 x 50	Beyaz / White	1	<b>1.210,00</b>

**Acil Stop Etiketleri (22mm Çapa Uygun)**

Emergency Stop Labels (Suitable for 22mm Diameter)



Ürün Kodu Product Code	Ürün Adı Product Name	Etiket Çapı Label Dia. (mm)	Delik Çapı Hole Dia. (mm)	Renk Color	Amb. Mik. Pack. Qty. (Ad./Pcs.)	Birim Fiyatı Unit Price (TL/Adet)
8022130350	<b>ASE60</b>	60	23,5	Sarı / Yellow	1	<b>32,00</b>



RCTL 50x15



HCTL 25x10

### Kablo Bağı ile Bağlanan Etiketler (Doğrudan Kablo Bağına Takılan)

Labels Assembled with Cable Ties (Directly Assembled to Cable Ties)

Ürün Kodu Product Code	Ürün Adı Product Name	Yazım Alanı Print Area (mm)	Renk Color	Açıklama Explanation	Amb. Mik. Pack. Qty. (Ad./Pcs.)	Birim Fiyatı Unit Price (TL/Rulo)	Adet Fiyatı Pcs. Price (TL/Ad.)
8021341019	<b>HCTL 25x10</b>	25 x 10	Beyaz / White	Altıgen / Hexagonal	250	<b>2.550,00</b>	<b>10,20</b>
8021342019	<b>RCTL 25x10</b>	25 x 10	Beyaz / White	Dikdörtgen / Rectangular	250	<b>2.550,00</b>	<b>10,20</b>
8021342029	<b>RCTL 50x15</b>	50 x 15	Beyaz / White	Dikdörtgen / Rectangular	250	<b>4.300,00</b>	<b>17,20</b>
8021342039	<b>RCTL 60x30</b>	60 x 30	Beyaz / White	Dikdörtgen / Rectangular	250	<b>4.600,00</b>	<b>18,40</b>



CM 1

### Kablo Bağı ile Bağlanan Etiketler (Etiket Kılıfıyla Bağlananlar)

Labels Assembled with Cable Ties (Assembled with Label Holder)

Ürün Kodu Product Code	Ürün Adı Product Name	Yazım Alanı Print Area (mm)	Renk Color	Açıklama Explanation	Amb. Mik. Pack. Qty. (Ad./Pcs.)	Birim Fiyatı Unit Price (TL/Amb.)	Adet Fiyatı Pcs. Price (TL/Ad.)
8021334009	<b>CM 1</b>		Beyaz / White	Etiket Kılıfı 1 Label Holder 1	100	<b>270,00</b>	<b>2,70</b>
8021334019	<b>CM 2</b>		Beyaz / White	Etiket Kılıfı 2 Label Holder 2	100	<b>410,00</b>	<b>4,10</b>

Boş yazım kağıtları paketin içerisinde.

Ürün Kodu Product Code	Ürün Adı Product Name	Renk Color	Ölçüler Dimensions		
			L	W	T
8021334009	<b>CM 1</b>	Beyaz / White	35	10	8
8021334019	<b>CM 2</b>	Beyaz / White	45	20	8

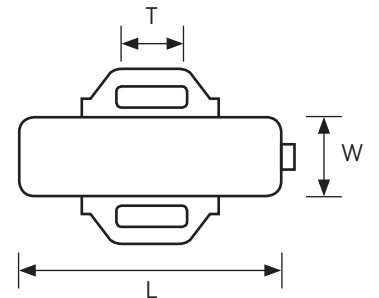

CM 1

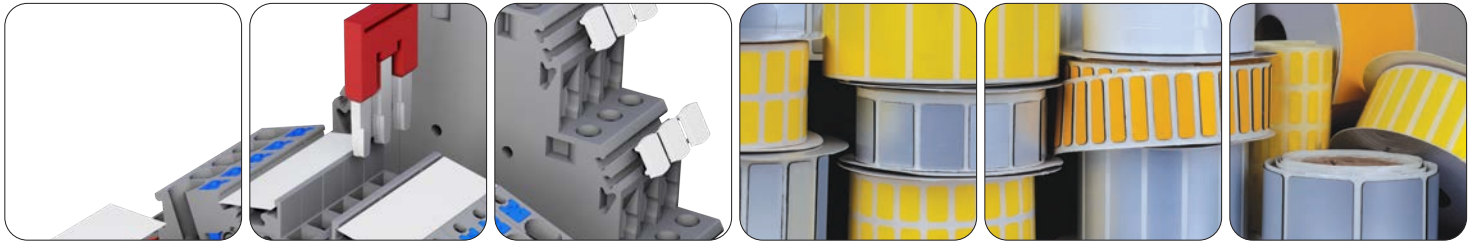

# t bloc

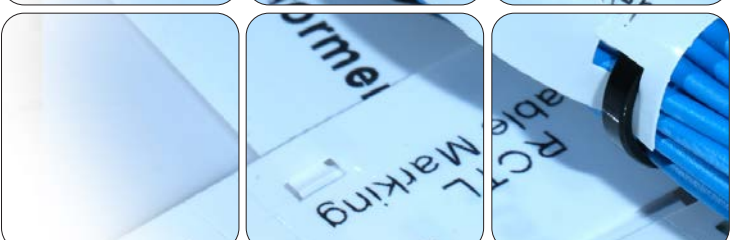
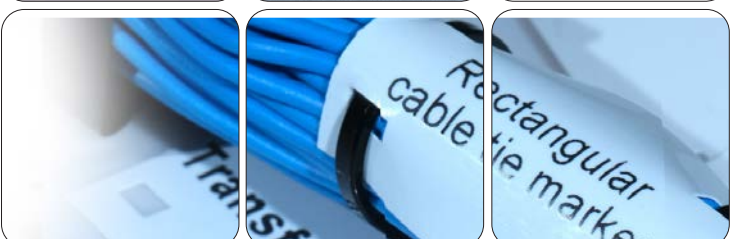
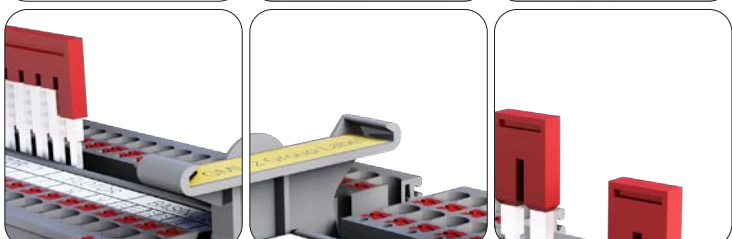
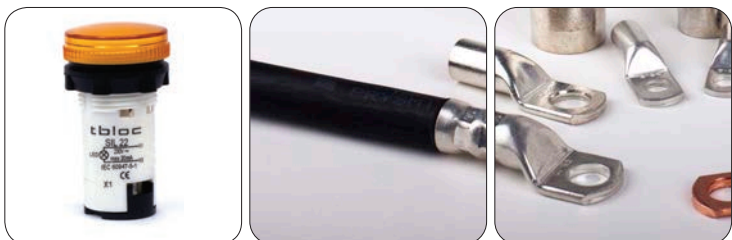
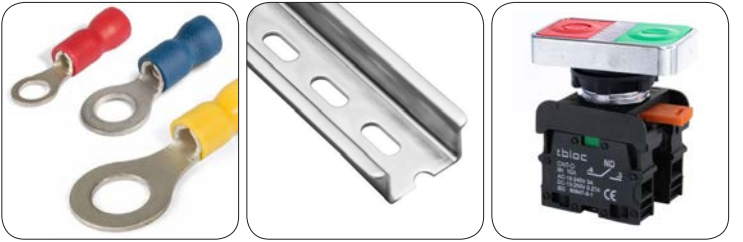





### Plastik Kablo Bağları

#### Plastic Cable Ties

Ürün Kodu Product Code	Ürün Adı Product Name	Ölçüler (BoyxEn) Dimensions (LxW) (mm)	Maks. Sıkma Çapı Max. Bundle Dia. (mm)	Min. Açılma Mukavemeti Min. Loop Tensile Strenght (kg.)	Amb. Mik. Pack. Qty (Adet/Pcs.)	Koli Mik. Carton Qty. (Adet/Pcs.)	Birim Fiyatı Unit Price (TL/100 Ad.)
8016330109	PCT 100 x 2.5 Beyaz / White	100 x 2.5	22	8	100	26.000	17,20
8016330110	PCT 100 x 2.5 Siyah / Black	100 x 2.5	22	8	100	26.000	17,20
8016330209	PCT 150 x 2.5 Beyaz / White	150 x 2.5	35	8	100	20.000	24,60
8016330210	PCT 150 x 2.5 Siyah / Black	150 x 2.5	35	8	100	20.000	24,60
8016330309	PCT 200 x 2.5 Beyaz / White	200 x 2.5	55	8	100	18.000	36,90
8016330310	PCT 200 x 2.5 Siyah / Black	200 x 2.5	55	8	100	18.000	36,90
8016330409	PCT 140 x 3.6 Beyaz / White	140 x 3.6	36	18	100	12.000	39,50
8016330410	PCT 140 x 3.6 Siyah / Black	140 x 3.6	36	18	100	12.000	39,50
8016330509	PCT 200 x 3.6 Beyaz / White	200 x 3.6	52	18	100	10.000	61,00
8016330510	PCT 200 x 3.6 Siyah / Black	200 x 3.6	52	18	100	10.000	61,00
8016330609	PCT 250 x 3.6 Beyaz / White	250 x 3.6	68	18	100	8.000	72,80
8016330610	PCT 250 x 3.6 Siyah / Black	250 x 3.6	68	18	100	8.000	72,80
8016330709	PCT 280 x 3.6 Beyaz / White	280 x 3.6	82	18	100	8.000	87,30
8016330710	PCT 280 x 3.6 Siyah / Black	280 x 3.6	82	18	100	8.000	87,30
8016330809	PCT 370 x 3.6 Beyaz / White	370 x 3.6	105	18	100	6.000	112,00
8016330810	PCT 370 x 3.6 Siyah / Black	370 x 3.6	105	18	100	6.000	112,00
8016331009	PCT 200 x 4.8 Beyaz / White	200 x 4.8	49	22	100	7.000	82,80
8016331010	PCT 200 x 4.8 Siyah / Black	200 x 4.8	49	22	100	7.000	82,80
8016331209	PCT 250 x 4.8 Beyaz / White	250 x 4.8	68	22	100	6.000	104,70
8016331210	PCT 250 x 4.8 Siyah / Black	250 x 4.8	68	22	100	6.000	104,70
8016331309	PCT 300 x 4.8 Beyaz / White	300 x 4.8	83	22	100	5.000	120,90
8016331310	PCT 300 x 4.8 Siyah / Black	300 x 4.8	83	22	100	5.000	120,90
8016331509	PCT 370 x 4.8 Beyaz / White	370 x 4.8	105	22	100	4.000	152,00
8016331510	PCT 370 x 4.8 Siyah / Black	370 x 4.8	105	22	100	4.000	152,00
8016331709	PCT 430 x 4.8 Beyaz / White	430 x 4.8	125	22	100	3.000	185,00
8016331710	PCT 430 x 4.8 Siyah / Black	430 x 4.8	125	22	100	3.000	185,00
8016332009	PCT 300 x 7.6 Beyaz / White	300 x 7.6	80	55	100	3.000	250,00
8016332010	PCT 300 x 7.6 Siyah / Black	300 x 7.6	80	55	100	3.000	250,00
8016332209	PCT 370 x 7.6 Beyaz / White	370 x 7.6	101	55	100	2.500	300,00
8016332210	PCT 370 x 7.6 Siyah / Black	370 x 7.6	101	55	100	2.500	300,00
8016332309	PCT 450 x 7.6 Beyaz / White	450 x 7.6	128	55	100	2.500	350,00
8016332310	PCT 450 x 7.6 Siyah / Black	450 x 7.6	128	55	100	2.500	350,00
8016332329	PCT 550 x 7.6 Beyaz / White	550 x 7.6	155	55	100	1.500	470,00
8016332320	PCT 550 x 7.6 Siyah / Black	550 x 7.6	155	55	100	1.500	470,00
8016332339	PCT 750 x 7.6 Beyaz / White	750 x 7.6	220	55	100	1.200	632,00
8016332330	PCT 750 x 7.6 Siyah / Black	750 x 7.6	220	55	100	1.200	632,00
8016332409	PCT 600 x 9.0 Beyaz / White	600 x 9.0	160	80	100	1.200	683,00
8016332410	PCT 600 x 9.0 Siyah / Black	600 x 9.0	160	80	100	1.200	683,00
8016332609	PCT 760 x 9.0 Beyaz / White	760 x 9.0	227	80	100	1.200	860,00
8016332610	PCT 760 x 9.0 Siyah / Black	760 x 9.0	227	80	100	1.200	860,00
8016332709	PCT 900 x 9.0 Beyaz / White	900 x 9.0	275	80	100	1.200	1.000,00
8016332710	PCT 900 x 9.0 Siyah / Black	900 x 9.0	275	80	100	1.200	1.000,00

- Siyah renkli kablo bağları UV (Ultraviyole) ışınlarına karşı dayanımlıdır.
- Black colored cable ties are UV (Ultraviolet) resistant.



### Paslanmaz elik Kablo Bařları - 304 Kalite

#### Stainless Steel Cable Ties - Grade 304

rn Kodu Product Code	rn Adı Product Name	ller (BoyxEen) Dimensions (LxW) (mm)	Maks. Sıkma apı Max. Bundle Dia. (mm)	Min. Aılma Mukavemeti Min. Loop Tensile Strenght (kg.)	Amb. Mik. Pack. Qty (Adet/Pcs.)	Koli Mik. Carton Qty. (Adet/Pcs.)	Birim Fiyatı Unit Price (TL/Ad.)
8016335010	<b>SSCT 150x4.6</b>	150x4.6	33	55	100	8.000	<b>3,55</b>
8016335020	<b>SSCT 200x4.6</b>	200x4.6	50	55	100	6.000	<b>3,95</b>
8016335030	<b>SSCT 250x4.6</b>	250x4.6	67	55	100	5.000	<b>4,40</b>
8016335040	<b>SSCT 300x4.6</b>	300x4.6	75	55	100	5.000	<b>4,70</b>
8016335050	<b>SSCT 370x4.6</b>	370x4.6	102	55	100	4.000	<b>5,10</b>
8016335060	<b>SSCT 450x4.6</b>	450x4.6	130	55	100	3.000	<b>5,80</b>
8016335070	<b>SSCT 520x4.6</b>	520x4.6	152	55	100	3.000	<b>6,50</b>
8016335080	<b>SSCT 680x4.6</b>	680x4.6	203	55	100	2.000	<b>7,90</b>
8016335090	<b>SSCT 840x4.6</b>	840x4.6	254	55	100	1.000	<b>9,60</b>
8016335100	<b>SSCT 200x7.9</b>	200x7.9	50	120	100	5.000	<b>5,70</b>
8016335110	<b>SSCT 300x7.9</b>	300x7.9	75	120	100	4.000	<b>6,40</b>
8016335120	<b>SSCT 370x7.9</b>	370x7.9	102	120	100	3.000	<b>7,20</b>
8016335130	<b>SSCT 450x7.9</b>	450x7.9	130	120	100	3.000	<b>8,60</b>
8016335140	<b>SSCT 520x7.9</b>	520x7.9	152	120	100	2.000	<b>9,60</b>
8016335150	<b>SSCT 680x7.9</b>	680x7.9	203	120	100	2.000	<b>12,10</b>
8016335160	<b>SSCT 840x7.9</b>	840x7.9	254	120	100	1.000	<b>13,50</b>
8016335170	<b>SSCT 1000x7.9</b>	1000x7.9	305	120	100	1.000	<b>18,10</b>



### Teknik zellikler

#### Technical Futures

<b>Malzeme</b> / Material	<b>304 kalite Paslanmaz elik</b> / 304 grade Stainless Steel
<b>Su Emilimi</b> / Water Absorption	<b>Yok</b> / No
<b>Alev Yrmeme</b> / Flame Retardant	<b>UL94V-2</b>
<b>UV Dayanıklılıęı</b> / UV Resistance	<b>Mkemmел</b> / Excellent
<b>Kimyasal Dayanım</b> / Chemical Resistance	<b>Mkemmел</b> / Excellent
<b>alıřma Sıcaklıęı</b> / Operating Temperature	<b>-80°C + 538°C</b>

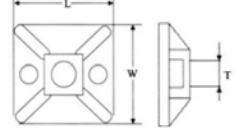

### Yapışkan Krořeler

#### Self Adhesive Tie Mounts

Ürün Kodu Product Code	Ürün Adı Product Name	Ölçüler Dimensions (mm)			Amb. Mik. Pack. Qty (Adet/Pcs.)	Birim Fiyatı Unit Price (TL/100 Adet)
		L	W	T		
8016333009	ATM 19 x 19 Beyaz / White	19	19	3,6	100	80,00
8016333010	ATM 19 x 19 Siyah / Black	19	19	3,6	100	80,00
8016333109	ATM 28 x 28 Beyaz / White	28	28	4,8	100	138,00
8016333110	ATM 28 x 28 Siyah / Black	28	28	4,8	100	138,00

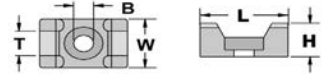

### Vidalı Krořeler

#### Screw Type Tie Mounts

Ürün Kodu Product Code	Ürün Adı Product Name	Ölçüler Dimensions					Amb. Mik. Pack. Qty (Adet/Pcs.)	Birim Fiyatı Unit Price (TL/100 Adet)
		L	W	H	T	B		
8016334009	STM 1 Beyaz / White	17,8	12,7	8,15	4,8	M3	250	60,00
8016334019	STM 2 Beyaz / White	25,4	16	10,8	9	M5	250	82,00
8016334010	STM 1 Siyah / Black	17,8	12,7	8,15	4,8	M3	250	60,00
8016334020	STM 2 Siyah / Black	25,4	16	10,8	9	M5	250	82,00



### Kablo Bađı Aleti

#### Cable Tie Tool

Ürün Kodu Product Code	Ürün Adı Product Name	Özellik Function	Maks. Kablo Bađı Eni Max. Cable Tie Width (mm)	Amb. Mik. Pack. Qty (Adet/Pcs.)	Birim Fiyatı Unit Price (TL/Adet)
8016334200	CTT1	Sıkma + Kesme Tightening + Cutting	4,8	1	600,00

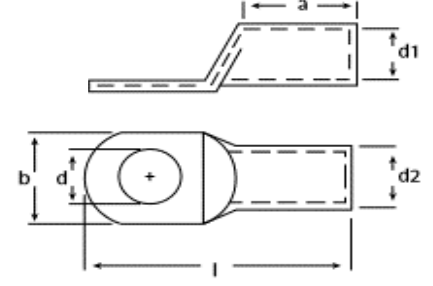

**Eko Seri Sıkmalı Kablo Pabuçları**

Economical Compression Cable Lugs

Ürün Kodu Product Code	Ürün Adı Product Name	Kesit Cross Sec. (mm <sup>2</sup> )	Ölçüler / Dimensions (mm)						Delik Çapı Hole Dia.	Amb. Mik. Pack. Qty. (Adet/Pcs.)	Birim Fiyatı Unit Price (TL/Adet)
			d	d1	d2	l	a	b			
8029320500	<b>CCL-E 16 mm<sup>2</sup> M6</b>	16	6,5	5,5	7	32,5	11	10,5	M6	500	<b>5,10</b>
8029320510	<b>CCL-E 16 mm<sup>2</sup> M8</b>	16	8,5	5,5	7	32,5	11	13	M8	500	<b>5,70</b>
8029320520	<b>CCL-E 25 mm<sup>2</sup> M8</b>	25	8,5	7	9	38,5	16	13	M8	300	<b>8,00</b>
8029320530	<b>CCL-E 35 mm<sup>2</sup> M8</b>	35	8,5	8,5	10,5	43,5	19	15,5	M8	200	<b>11,20</b>
8029320540	<b>CCL-E 50 mm<sup>2</sup> M10</b>	50	10,5	10	12	51,5	21	17,6	M10	125	<b>17,00</b>
8029320550	<b>CCL-E 70 mm<sup>2</sup> M10</b>	70	10,5	11,5	14	55,5	23	20,7	M10	100	<b>26,00</b>
8029320560	<b>CCL-E 95 mm<sup>2</sup> M12</b>	95	13	13,5	16	58,5	26	23,5	M12	75	<b>31,50</b>
8029320570	<b>CCL-E 120 mm<sup>2</sup> M12</b>	120	13	15,5	18	71	29	26,7	M12	50	<b>46,00</b>
8029320580	<b>CCL-E 150 mm<sup>2</sup> M12</b>	150	13	16,5	20	76	30	29,2	M12	30	<b>72,00</b>
8029320590	<b>CCL-E 185 mm<sup>2</sup> M16</b>	185	17	18,5	22	82	33	32,3	M16	25	<b>82,00</b>
8029320600	<b>CCL-E 240 mm<sup>2</sup> M16</b>	240	17	21,5	25,5	91	38	37,6	M16	20	<b>128,00</b>

Malzeme : EN 13600 Standardında elektrolitik bakır  
Kaplama : Minimum 3 mikron (µm) Kalay Kaplama

Material : EN 13600 Standarts Electrolytically Tin (E-Cu) Plated Copper  
Plating : Minimum 3 microns (µm) Tin Plated



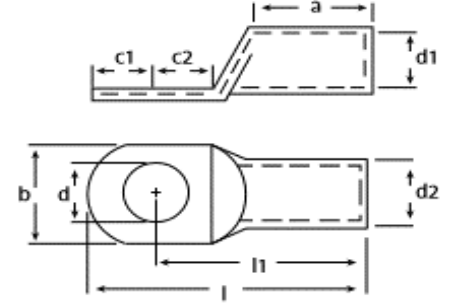

### Standart Seri Sıkmalı Kablo Pabuçları

#### Standart Range Compression Lugs

Ürün Kodu Product Code	Ürün Adı Product Name	Kesit Cross Sec. (mm <sup>2</sup> )	Ölçüler / Dimensions (mm)										Delik Çapı Hole Dia.	Amb. Mik. Pack. Qty. (Adet/Pcs.)	Birim Fiyatı Unit Price (TL/Adet)
			d	d1	d2	l	l1	a	b	c1	c2				
8029320610	CCL 10mm <sup>2</sup> M6	10	6,5	4,4	6	27,5	21,7	10	10,4	6	6	M6	500	5,40	
8029320620	CCL 10mm <sup>2</sup> M8	10	8,5	4,4	6	27,5	21,7	10	13,7	6	6	M8	500	5,40	
8029320630	CCL 16mm <sup>2</sup> M6	16	6,5	5,5	8	32,6	24,9	12	11,4	7	8	M6	300	9,00	
8029320640	CCL 16mm <sup>2</sup> M8	16	8,5	5,5	8	32,6	24,9	12	13,9	7	8	M8	300	9,00	
8029320641	CCL 16mm <sup>2</sup> M10	16	10,5	5,5	8	32,6	24,9	12	16,1	7	8	M10	300	9,00	
8029320649	CCL 25mm <sup>2</sup> M6	25	6,5	6,8	9	39	32,3	16	13,6	6,8	9,2	M6	200	14,00	
8029320650	CCL 25mm <sup>2</sup> M8	25	8,5	6,8	9	39	32,3	16	13,7	6,8	9,2	M8	200	13,80	
8029320651	CCL 25mm <sup>2</sup> M10	25	10,5	7	9,5	42	34,1	16	16,1	6,8	11	M10	200	14,00	
8029320659	CCL 35mm <sup>2</sup> M6	35	6,5	8,2	11	44	35,6	19	15,9	8,3	9,7	M6	150	18,50	
8029320660	CCL 35mm <sup>2</sup> M8	35	8,5	8,2	11	44	35,6	19	15,9	8,3	9,7	M8	150	18,40	
8029320661	CCL 35mm <sup>2</sup> M10	35	10,5	8,2	11	48	37,9	19	15,8	10	12	M10	150	18,40	
8029320669	CCL 50mm <sup>2</sup> M8	50	8,5	9,5	12	47,5	39,3	21	17,8	8,3	9,7	M8	100	29,50	
8029320670	CCL 50mm <sup>2</sup> M10	50	10,5	9,5	12	51,5	41,6	21	17,9	10	12	M10	100	29,90	
8029320671	CCL 50mm <sup>2</sup> M12	50	13	10,1	13	51,5	41,6	21	19,2	10	12	M12	100	29,90	
8029320672	CCL 50mm <sup>2</sup> M14	50	15	10,1	13	56,5	44,6	21	20,7	12	15	M14	100	37,00	
8029320679	CCL 70mm <sup>2</sup> M8	70	8,5	11,2	14,5	54,6	44,5	23	21,2	10	12	M8	75	43,00	
8029320680	CCL 70mm <sup>2</sup> M10	70	10,5	11,2	14,5	54,6	44,5	23	21,2	10	12	M10	75	41,00	
8029320681	CCL 70mm <sup>2</sup> M12	70	13	11,2	14,5	54,6	44,5	23	21,3	10	12	M12	75	41,00	
8029320682	CCL 70mm <sup>2</sup> M14	70	15	11,2	14,5	62,6	47,5	23	21,5	15	15	M14	75	49,00	
8029320689	CCL 95mm <sup>2</sup> M8	95	8,5	13,4	17	58,8	48,9	26	24,7	10	12	M8	50	52,00	
8029320690	CCL 95mm <sup>2</sup> M10	95	10,5	13,4	17	58,8	48,9	26	24,7	10	12	M10	50	51,00	
8029320700	CCL 95mm <sup>2</sup> M12	95	13	13,4	17	58,8	48,9	26	24,6	10	12	M12	50	49,00	
8029320709	CCL 120mm <sup>2</sup> M10	120	10,5	15,5	19	69	55,9	29	28,1	13	14,5	M10	40	75,00	
8029320710	CCL 120mm <sup>2</sup> M12	120	13	15,5	19	69	55,9	29	28,2	13	14,5	M12	40	69,00	
8029320711	CCL 120mm <sup>2</sup> M16	120	17	15,5	19	69	55,9	29	28,2	13	14,5	M16	40	69,00	
8029320719	CCL 150mm <sup>2</sup> M10	150	10,5	16,5	21	76,5	59,9	30	30,2	16,5	16,5	M10	30	106,90	
8029320720	CCL 150mm <sup>2</sup> M12	150	13	16,5	21	76,5	59,9	30	30,1	16,5	16,5	M12	30	105,00	
8029320721	CCL 150mm <sup>2</sup> M16	150	17	16,5	21	76,5	59,9	30	30,1	16,5	16,5	M16	30	105,00	
8029320729	CCL 185mm <sup>2</sup> M12	185	13	18,5	23	82,5	65,6	33	34,2	17	18	M12	25	125,00	
8029320730	CCL 185mm <sup>2</sup> M16	185	17	18,5	23	82,5	65,6	33	34,1	17	18	M16	25	120,00	
8029320739	CCL 240mm <sup>2</sup> M12	240	13	21	26	89	72,1	38	38,2	17	18	M12	20	168,00	
8029320740	CCL 240mm <sup>2</sup> M16	240	17	21	26	89	72,1	38	38,2	17	18	M16	20	167,00	

Malzeme : EN 13600 Standardında elektrolitik bakır  
Kaplama : Minimum 3 mikron (µm) Kalay Kaplama

Material : EN 13600 Standarts Electrolytically Tin (E-Cu) Plated Copper  
Plating : Minimum 3 microns (µm) Tin Plated

\*\* Koyu renk ile işaretlenmiş kablo pabuçları standart ürünlerimiz olup, diğer kalemler için lütfen stok durumunu sorunuz.

\*\* Bold colored Lugs items are our standart sizes, pls advise for other items stocks availability

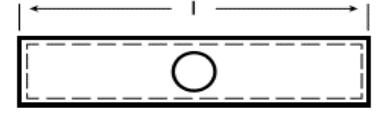

### Eko Seri Ek Muflar

#### Economical Range Compression Butt Terminals

Ürün Kodu Product Code	Ürün Adı Product Name	Kesit Cross Sec. (mm <sup>2</sup> )	Uzunluk Length (l) mm	Amb. Mik. Pack. Qty. (Adet/Pcs.)	Birim Fiyatı Unit Price (TL/Adet)
8029320750	CBT-E 16 mm <sup>2</sup>	16	32	300	6,00
8029320760	CBT-E 25 mm <sup>2</sup>	25	41	200	9,80
8029320770	CBT-E 35 mm <sup>2</sup>	35	46	150	12,80
8029320780	CBT-E 50 mm <sup>2</sup>	50	54	125	18,00
8029320790	CBT-E 70 mm <sup>2</sup>	70	58	100	28,50
8029320800	CBT-E 95 mm <sup>2</sup>	95	62	60	34,00
8029320810	CBT-E 120 mm <sup>2</sup>	120	74	40	49,00
8029320820	CBT-E 150 mm <sup>2</sup>	150	80	30	77,50
8029320830	CBT-E 185 mm <sup>2</sup>	185	86	22	90,00
8029320840	CBT-E 240 mm <sup>2</sup>	240	95	15	130,00

Malzeme : EN 13600 Standardında elektrolitik bakır  
Kaplama : Minimum 3 mikron (µm) Kalay Kaplama

Material : EN 13600 Standarts Electrolytically Tin (E-Cu) Plated Copper  
Plating : Minimum 3 microns (µm) Tin Plated

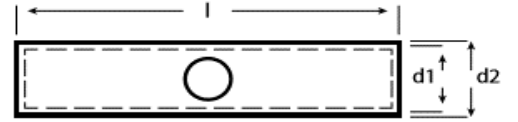

### Standart Seri Ek Muflar

#### Standard Range Compression Butt Terminals

Ürün Kodu Product Code	Ürün Adı Product Name	Kesit Cross Sec. (mm <sup>2</sup> )	Ölçüler / Dimensions (mm)			Amb. Mik. Pack. Qty. (Adet/Pcs.)	Birim Fiyatı Unit Price (TL/Adet)
			d1	d2	l		
8029320845	CBT 10 mm <sup>2</sup>	10	4,4	6	27	400	5,75
8029320850	CBT 16 mm <sup>2</sup>	16	5,5	8	32	250	9,50
8029320860	CBT 25 mm <sup>2</sup>	25	7	9	40,5	200	14,50
8029320870	CBT 35 mm <sup>2</sup>	35	8,2	11	45,5	150	25,50
8029320880	CBT 50 mm <sup>2</sup>	50	9,5	13	53,5	80	34,00
8029320890	CBT 70 mm <sup>2</sup>	70	11,2	14,5	57,5	60	46,80
8029320900	CBT 95 mm <sup>2</sup>	95	13,4	17	61,5	40	62,00
8029320910	CBT 120 mm <sup>2</sup>	120	15	19,5	74	30	84,00
8029320920	CBT 150 mm <sup>2</sup>	150	16,5	21	79	25	132,00
8029320930	CBT 185 mm <sup>2</sup>	185	19	24	85	18	142,00
8029320940	CBT 240 mm <sup>2</sup>	240	21	26	95	13	190,00

Malzeme : EN 13600 Standardında elektrolitik bakır  
Kaplama : Minimum 3 mikron (µm) Kalay Kaplama

Material : EN 13600 Standarts Electrolytically Tin (E-Cu) Plated Copper  
Plating : Minimum 3 microns (µm) Tin Plated



Malzeme: Bakır, Kalay Kaplı  
Material: Copper, Tin Plated  
İzolasyon / Isolation PA66

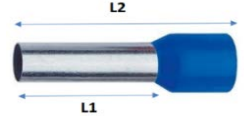

### İzoleli Kablo Yüksükleri

#### Insulated End Sleeves

Ürün Kodu Product Code	Ürün Adı Product Name	Ölçüler Dimensions (mm)		Kesit Cross Sect. (mm <sup>2</sup> )	AWG	Norm	Amb. Mik. Pack. Qty (Adet/Pcs.)	Birim Fiyatı Unit Price (TL/Adet)
		L1	L2					
8017335000	IES 0,50/8 Turuncu / Orange	8	12	0,5	20	Alman / German	1.000	0,1850
8017335010	IES 0,75/8 Beyaz / White	8	14	0,75	18	Alman / German	1.000	0,1850
8017335020	IES 1,0/8 Sarı / Yellow	8	14	1	17	Alman / German	1.000	0,2020
8017335030	IES 1,5/8 Kırmızı / Red	8	14	1,5	16	Alman / German	1.000	0,2250
8017335040	IES 2,5/8 Mavi / Blue	8	14	2,5	14	Alman / German	500	0,2800
8017335050	IES 4,0/10 Gri / Grey	10	17	4	12	Alman / German	500	0,4400
8017335060	IES 6,0/12 Siyah / Black	12	20	6	10	Alman / German	250	0,6100
8017335070	IES 10,0/12 Fildişi / Ivory	12	22	10	8	Alman / German	100	0,8800
8017335080	IES 16,0/12 Yeşil / Green	12	24	16	6	Alman / German	100	1,0600
8017335090	IES 25,0/16 Kahve / Brown	16	28	25	4	Alman / German	50	2,1200
8017335100	IES 35,0/16 Bej / Beige	16	30	35	2	Alman / German	50	2,4200
8017335110	IES 50,0/20 Zeytin Yeşili / Olive Green	20	36	50	1	Alman / German	25	4,9000

Ürün Kodu Product Code	Ürün Adı Product Name	Ölçüler Dimensions (mm)		Kesit Cross Sect. (mm <sup>2</sup> )	AWG	Norm	Amb. Mik. Pack. Qty (Adet/Pcs.)	Birim Fiyatı Unit Price (TL/Adet)
		L1	L2					
8017335005	IES 0,50/8 Beyaz / White	8	12	0,5	20	Fransız / French	1.000	0,1850
8017335015	IES 0,75/8 Mavi / Blue	8	14	0,75	18	Fransız / French	1.000	0,1850
8017335025	IES 1,0/8 Kırmızı / Red	8	14	1	17	Fransız / French	1.000	0,2020
8017335035	IES 1,5/8 Siyah / Black	8	14	1,5	16	Fransız / French	1.000	0,2250
8017335045	IES 2,5/8 Gri / Grey	8	14	2,5	14	Fransız / French	500	0,2800
8017335055	IES 4,0/10 Turuncu / Orange	10	17	4	12	Fransız / French	500	0,4400
8017335065	IES 6,0/12 Yeşil / Green	12	20	6	10	Fransız / French	250	0,6100
8017335075	IES 10,0/12 Kahve / Brown	12	22	10	8	Fransız / French	100	0,8800
8017335085	IES 16,0/12 Bej / Beige	12	24	16	6	Fransız / French	100	1,0600
8017335095	IES 25,0/16 Siyah / Black	16	28	25	4	Fransız / French	50	2,1200
8017335105	IES 35,0/16 Kırmızı / Red	16	30	35	2	Fransız / French	50	2,4200
8017335115	IES 50,0/20 Mavi / Blue	20	36	50	1	Fransız / French	25	4,9000





Malzeme: Bakır, Kalay Kaplı  
Material: Copper, Tin Plated  
İzolasyon / Isolation PA66

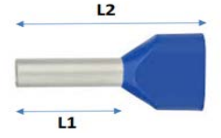

## Çift Girişli Kablo Yüksükleri

### Twin Cord End Sleeves

Ürün Kodu Product Code	Ürün Adı Product Name	Ölçüler Dimensions (mm)		Kesit Cross Sect. (mm <sup>2</sup> )	Norm	Amb. Mik. Pack. Qty (Adet/Pcs.)	Birim Fiyatı Unit Price (TL/Adet)
		L1	L2				
8017335400	IES 2x0,50/8 Turuncu / Orange	8	14	2 x 0,5	Alman / German	1.000	0,3500
8017335410	IES 2x0,75/8 Beyaz / White	8	14	2 x 0,75	Alman / German	500	0,3550
8017335420	IES 2x1,0/8 Sarı / Yellow	8	14	2 x 1,0	Alman / German	500	0,3800
8017335430	IES 2x1,5/8 Kırmızı / Red	8	14	2 x 1,5	Alman / German	500	0,4500
8017335440	IES 2x2,5/10 Mavi / Blue	10	14	2 x 2,5	Alman / German	250	0,7400
8017335450	IES 2x4,0/12 Gri / Grey	12	17	2 x 4,0	Alman / German	200	0,8600
8017335460	IES 2x6,0/14 Siyah / Black	14	20	2 x 6,0	Alman / German	100	1,2100
8017335470	IES 2x10,0/14 Fildişi / Ivory	14	27	2 x 10	Alman / German	50	1,7000
8017335480	IES 2x16,0/14 Yeşil / Green	14	31	2 x 16	Alman / German	50	2,6000

Ürün Kodu Product Code	Ürün Adı Product Name	Ölçüler Dimensions (mm)		Kesit Cross Sect. (mm <sup>2</sup> )	Norm	Amb. Mik. Pack. Qty (Adet/Pcs.)	Birim Fiyatı Unit Price (TL/Adet)
		L1	L2				
8017335405	IES 2x0,50/8 Beyaz / White	8	14	2 x 0,5	Fransız / French	1.000	0,3500
8017335415	IES 2x0,75/8 Mavi / Blue	8	14	2 x 0,75	Fransız / French	500	0,3550
8017335425	IES 2x1,0/8 Kırmızı / Red	8	14	2 x 1,0	Fransız / French	500	0,3800
8017335435	IES 2x1,5/8 Siyah / Black	8	14	2 x 1,5	Fransız / French	500	0,4500
8017335445	IES 2x2,5/10 Gri / Grey	10	14	2 x 2,5	Fransız / French	250	0,7400
8017335455	IES 2x4,0/12 Turuncu / Orange	12	17	2 x 4,0	Fransız / French	200	0,8600
8017335465	IES 2x6,0/14 Yeşil / Green	14	20	2 x 6,0	Fransız / French	100	1,2100
8017335475	IES 2x10,0/14 Kahve / Brown	14	27	2 x 10	Fransız / French	50	1,7000
8017335485	IES 2x16,0/14 Bej / Beige	14	31	2 x 16	Fransız / French	50	2,6000



Malzeme: Bakır, Kalay Kaplı  
Material: Copper, Tin Plated

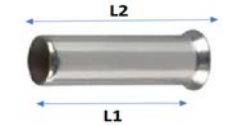

## İzolesiz Kablo Yüksükleri

### Non-insulated End Sleeves

Ürün Kodu Product Code	Ürün Adı Product Name	Ölçüler Dimensions (mm)		Kesit Cross Sect. (mm <sup>2</sup> )	AWG	Amb. Mik. Pack. Qty (Adet/Pcs.)	Birim Fiyatı Unit Price (TL/Adet)
		L1	L2				
8017335220	ES 0,50/10	8	10	0,50	20	2.000	0,1785
8017335230	ES 0,75/10	8	10	0,75	18	2.000	0,1785
8017335240	ES 1,0/10	8	10	1,00	17	2.000	0,1850
8017335250	ES 1,5/10	8	10	1,50	15	2.000	0,1990
8017335260	ES 2,5/12	8	12	2,50	13	2.000	0,2570
8017335270	ES 4,0/12	10	12	4,00	11	1.000	0,3800
8017335280	ES 6,0/12	10	12	6,00	9	500	0,5100
8017335290	ES 10,0/15	12	15	10,00	7	200	0,7700
8017335300	ES 16,0/15	12	15	16,00	5	200	0,9100
8017335310	ES 25,0/16	16	16	25,00	4	100	1,7200
8017335320	ES 35,0/16	16	16	35,00	2	100	1,9500
8017335330	ES 50,0/20	20	20	50,00	1	50	3,9000





Malzeme: Bakır, Nikel Kaplı  
Material: Copper, Nickel Plated  
İzolasyon / Isolation PVC

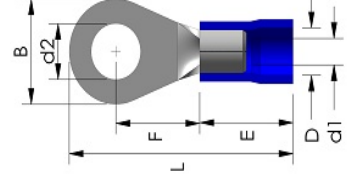

## Yuvarlak Pabuçlar

### Insulated Ring Terminals

Ürün Kodu Product Code	Ürün Adı Product Name	Kesit Cross Sect. (mm <sup>2</sup> )	Ölçüler Dimensions (mm)							Renk Color	Amb. Mik. Pack. Qty (Adet/Pcs.)	Birim Fiyatı Unit Price (TL/Adet)
			d2	B	F	L	E	D	d1			
8018335500	<b>IRT 301</b>	0,5 - 1,5	3,2	5,5	4	16,7	10	4,1	1,7	Kırmızı / Red	200	<b>0,5800</b>
8018335510	<b>IRT 351</b>	0,5 - 1,5	3,7	5,5	4	16,7	10	4,1	1,7	Kırmızı / Red	200	<b>0,8200</b>
8018335520	<b>IRT 401</b>	0,5 - 1,5	4,3	6,6	6,3	19,6	10	4,1	1,7	Kırmızı / Red	200	<b>0,8600</b>
8018335530	<b>IRT 501</b>	0,5 - 1,5	5,3	8	7	21	10	4,1	1,7	Kırmızı / Red	200	<b>0,8700</b>
8018335540	<b>IRT 601</b>	0,5 - 1,5	6,5	11,6	11,1	26,8	10	4,1	1,7	Kırmızı / Red	200	<b>1,3600</b>
8018335550	<b>IRT 801</b>	0,5 - 1,5	8,4	11,6	11,1	26,8	10	4,1	1,7	Kırmızı / Red	200	<b>1,3900</b>
8018335560	<b>IRT 302</b>	1,5 - 2,5	3,2	6,4	4,3	17,5	10	4,5	2,3	Mavi / Blue	200	<b>1,0700</b>
8018335570	<b>IRT 402</b>	1,5 - 2,5	4,3	6,6	6,3	19,5	10	4,5	2,3	Mavi / Blue	200	<b>1,0900</b>
8018335580	<b>IRT 502</b>	1,5 - 2,5	5,3	8,5	7,8	22	10	4,5	2,3	Mavi / Blue	200	<b>1,1000</b>
8018335590	<b>IRT 602</b>	1,5 - 2,5	6,5	12	11	27	10	4,5	2,3	Mavi / Blue	200	<b>1,5500</b>
8018335600	<b>IRT 802</b>	1,5 - 2,5	8,4	12	11	27	10	4,5	2,3	Mavi / Blue	200	<b>1,5700</b>
8018335610	<b>IRT 1002</b>	1,5 - 2,5	10,5	13,6	13,9	30,7	10	4,5	2,3	Mavi / Blue	100	<b>1,5900</b>
8018335620	<b>IRT 406</b>	4,0 - 6,0	4,3	7,2	5,9	22	12,5	6,5	3,4	Sarı / Yellow	75	<b>2,2600</b>
8018335630	<b>IRT 506</b>	4,0 - 6,0	5,3	9,5	8,3	25,5	12,5	6,5	3,4	Sarı / Yellow	75	<b>2,2700</b>
8018335640	<b>IRT 606</b>	4,0 - 6,0	6,5	12	10,5	29	12,5	6,5	3,4	Sarı / Yellow	75	<b>2,5100</b>
8018335650	<b>IRT 806</b>	4,0 - 6,0	8,4	15	13,7	33,7	12,5	6,5	3,4	Sarı / Yellow	75	<b>3,2800</b>
8018335660	<b>IRT 1006</b>	4,0 - 6,0	10,5	15	13,7	33,7	12,5	6,5	3,4	Sarı / Yellow	75	<b>3,2600</b>
8018335670	<b>IRT 1206</b>	4,0 - 6,0	13	19,2	16	38,1	12,5	6,5	3,4	Sarı / Yellow	75	<b>3,3200</b>
8018335680	<b>IRT 510</b>	8,0 - 10,0	5,3	12	9,7	32,5	17	8	4,5	Kırmızı / Red	50	<b>4,0400</b>
8018335690	<b>IRT 610</b>	8,0 - 10,0	6,7	12	9,7	32,5	17	8	4,5	Kırmızı / Red	50	<b>4,6800</b>



Malzeme: Bakır, Nikel Kaplı  
Material: Copper, Nickel Plated  
İzolasyon / Isolation PVC

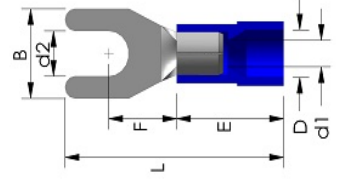

### Çatal Pabuçlar

#### Insulated Fork Terminals

Ürün Kodu Product Code	Ürün Adı Product Name	Kesit Cross Sect. (mm <sup>2</sup> )	Ölçüler Dimensions (mm)							Renk Color	Amb. Mik. Pack. Qty (Adet/Pcs.)	Birim Fiyatı Unit Price (TL/Adet)
			d2	B	F	L	E	D	d1			
8018335700	<b>IFT 301</b>	0,5 - 1,5	3,2	5,8	6,3	21	10	4,1	1,7	Kırmızı / Red	200	<b>0,7800</b>
8018335720	<b>IFT 401</b>	0,5 - 1,5	4,3	6,4	6,3	20,6	10	4,1	1,7	Kırmızı / Red	200	<b>0,8100</b>
8018335730	<b>IFT 501</b>	0,5 - 1,5	5,3	8	7	21	10	4,1	1,7	Kırmızı / Red	200	<b>0,8400</b>
8018335740	<b>IFT 601</b>	0,5 - 1,5	6,5	12	11	27,2	10	4,1	1,7	Kırmızı / Red	200	<b>0,9400</b>
8018335750	<b>IFT 302</b>	1,5 - 2,5	3,2	5,8	6,3	21	10	4,2	2,3	Mavi / Blue	200	<b>0,8700</b>
8018335760	<b>IFT 402</b>	1,5 - 2,5	4,3	6,4	6,3	21	10	4,2	2,3	Mavi / Blue	200	<b>0,8900</b>
8018335770	<b>IFT 502</b>	1,5 - 2,5	5,3	9,5	7,2	22	10	4,2	2,3	Mavi / Blue	200	<b>0,9100</b>
8018335780	<b>IFT 602</b>	1,5 - 2,5	6,5	12	11	27,2	10	4,2	2,3	Mavi / Blue	200	<b>1,2200</b>
8018335790	<b>IFT 406</b>	4,0 - 6,0	4,3	8,5	7,5	25,2	12,5	6,5	3,4	Sarı / Yellow	75	<b>1,9800</b>
8018335800	<b>IFT 506</b>	4,0 - 6,0	5,3	9,5	7,5	25,2	12,5	6,5	3,4	Sarı / Yellow	75	<b>2,0150</b>
8018335810	<b>IFT 606</b>	4,0 - 6,0	6,5	9,5	7,5	25,2	12,5	6,5	3,4	Sarı / Yellow	75	<b>2,7100</b>
8018335820	<b>IFT 806</b>	4,0 - 6,0	8,4	13,5	10,5	30	12,5	6,5	3,4	Sarı / Yellow	75	<b>3,0900</b>



Malzeme: Bakır, Pirinç Kaplı  
Material: Copper, Brass Plated  
İzolasyon / Isolation PVC

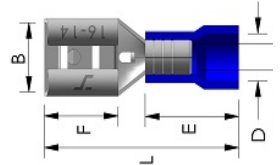

### Faston Dişi Pabuçlar

#### Fast-on Female Terminals

Ürün Kodu Product Code	Ürün Adı Product Name	Kesit Cross Sect. (mm <sup>2</sup> )	Ölçüler Dimensions (mm)					Renk Color	Amb. Mik. Pack. Qty (Adet/Pcs.)	Birim Fiyatı Unit Price (TL/Adet)
			B	F	L	E	D			
8018336030	<b>FFT 1288</b>	0,5 - 1,5	3,2	6,4	18,8	10	3,5	Kırmızı / Red	200	<b>0,7000</b>
8018336100	<b>FFT 1488</b>	0,5 - 1,5	5	6,4	19,2	10	3,5	Kırmızı / Red	200	<b>0,8600</b>
8018336110	<b>FFT 1638</b>	0,5 - 1,5	6,6	7,2	20,8	10	3,5	Kırmızı / Red	200	<b>1,1200</b>
8018336115	<b>FFT 2288</b>	1,5 - 2,5	3,2	6,4	19,2	10	4,2	Mavi / Blue	150	<b>0,8600</b>
8018336120	<b>FFT 2488</b>	1,5 - 2,5	5	6,4	19,2	10	4,2	Mavi / Blue	150	<b>0,9800</b>
8018336130	<b>FFT 2638</b>	1,5 - 2,5	6,6	7,2	20,8	10	4,2	Mavi / Blue	150	<b>1,1200</b>
8018336140	<b>FFT 5638</b>	4,0 - 6,0	6,6	7,2	23,3	13	5,6	Sarı / Yellow	100	<b>1,3700</b>



Malzeme: Bakır, Pirinç Kaplı  
Material: Copper, Brass Plated  
İzolasyon / Isolation PVC

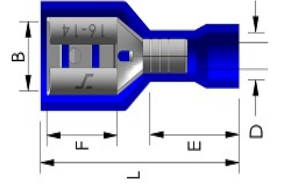

### İzoleli Faston Dişi Pabuçlar

#### Insulated Fast-on Female Terminals

Ürün Kodu Product Code	Ürün Adı Product Name	Kesit Cross Sect. (mm <sup>2</sup> )	Ölçüler Dimensions (mm)					Renk Color	Amb. Mik. Pack. Qty (Adet/Pcs.)	Birim Fiyatı Unit Price (TL/Adet)
			B	F	L	E	D			
8018336300	<b>IFFT 1288</b>	0,5 - 1,5	3,2	6,4	18,8	10	3,5	Kırmızı / Red	100	<b>1,0300</b>
8018336310	<b>IFFT 1488</b>	0,5 - 1,5	5	6,4	19,2	10	3,5	Kırmızı / Red	100	<b>1,1000</b>
8018336320	<b>IFFT 1638</b>	0,5 - 1,5	6,6	7,2	20,8	10	3,5	Kırmızı / Red	100	<b>1,4900</b>
8018336325	<b>IFFT 2288</b>	1,5 - 2,5	3,2	6,4	20,0	10	4,2	Mavi / Blue	100	<b>1,1000</b>
8018336330	<b>IFFT 2488</b>	1,5 - 2,5	5	6,4	19,2	10	4,2	Mavi / Blue	100	<b>1,1200</b>
8018336340	<b>IFFT 2638</b>	1,5 - 2,5	6,6	7,2	20,8	10	4,2	Mavi / Blue	100	<b>1,4700</b>
8018336350	<b>IFFT 5638</b>	4,0 - 6,0	6,6	7,2	23,8	13	5,6	Sarı / Yellow	75	<b>1,6200</b>



Malzeme: Bakır, Pirinç Kaplı  
Material: Copper, Brass Plated  
İzolasyon / Isolation PVC

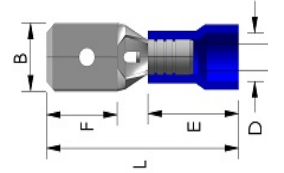

### Faston Erkek Pabuçlar

#### Fast-on Male Terminals

Ürün Kodu Product Code	Ürün Adı Product Name	Kesit Cross Sect. (mm <sup>2</sup> )	Ölçüler Dimensions (mm)					Renk Color	Amb. Mik. Pack. Qty (Adet/Pcs.)	Birim Fiyatı Unit Price (TL/Adet)
			B	F	L	E	D			
8018336150	<b>FMT 1288</b>	0,5 - 1,5	2,8	6,5	18,7	10	3,5	Kırmızı / Red	200	<b>0,7800</b>
8018336160	<b>FMT 1488</b>	0,5 - 1,5	4,8	6,7	19,3	10	3,5	Kırmızı / Red	200	<b>0,7900</b>
8018336170	<b>FMT 1638</b>	0,5 - 1,5	6,3	7,7	20,8	10	3,5	Kırmızı / Red	1200	<b>0,9300</b>
8018336175	<b>FMT 2288</b>	1,5 - 2,5	2,8	6,7	19,3	10	4,2	Mavi / Blue	200	<b>0,7900</b>
8018336180	<b>FMT 2488</b>	1,5 - 2,5	4,8	6,7	19,3	10	4,2	Mavi / Blue	200	<b>0,7900</b>
8018336190	<b>FMT 2638</b>	1,5 - 2,5	6,3	7,7	20,8	10	4,2	Mavi / Blue	200	<b>1,0200</b>
8018336200	<b>FMT 5638</b>	4,0 - 6,0	6,3	7,7	24	13	5,6	Sarı / Yellow	100	<b>1,2400</b>



Malzeme: Bakır, Kalay Kaplı  
Material: Copper, Tin Plated  
İzolasyon / Isolation PVC

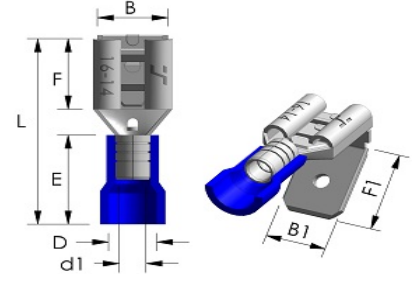

### Geri Dönüşlü Pabuçlar

#### Piggy Back Terminals

Ürün Kodu Product Code	Ürün Adı Product Name	Kesit Cross Sect. (mm <sup>2</sup> )	Ölçüler Dimensions (mm)								Renk Color	Amb. Mik. Pack. Qty (Adet/Pcs.)	Birim Fiyatı Unit Price (TL/Adet)
			B	B1	F	F1	L	E	D	d1			
8018336460	<b>PBT 1638</b>	0,5 - 1,5	6,6	6,3	8	8,2	22	10	3,5	1,7	Kırmızı / Red	100	<b>1,6900</b>
8018336470	<b>PBT 2638</b>	1,5 - 2,5	6,6	6,3	8	8,2	22	10	4,2	2,3	Mavi / Blue	100	<b>1,7300</b>
8018336480	<b>PBT 5638</b>	4,0 - 6,0	6,6	6,3	8	8,2	25	13	5,6	3,4	Sarı / Yellow	75	<b>1,8800</b>



Malzeme: Bakır, Kalay Kaplı  
Material: Copper, Tin Plated  
İzolasyon / Isolation PVC

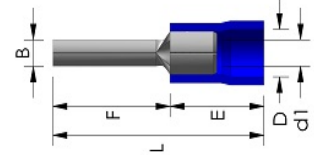

### İğne Tip Pabuçlar

#### Insulated Pin Terminals

Ürün Kodu Product Code	Ürün Adı Product Name	Kesit Cross Sect. (mm <sup>2</sup> )	Ölçüler Dimensions (mm)						Renk Color	Amb. Mik. Pack. Qty (Adet/Pcs.)	Birim Fiyatı Unit Price (TL/Adet)
			B	F	L	E	D	d1			
8018335900	<b>IPT 1/1,5</b>	0,5 - 1,5	1,9	12	22	10	4,3	1,7	Kırmızı / Red	200	<b>0,9400</b>
8018335910	<b>IPT 1/2,5</b>	1,5 - 2,5	1,9	12	22	10	4,8	2,3	Mavi / Blue	200	<b>1,1200</b>
8018335920	<b>IPT 1/6</b>	4,0 - 6,0	2,8	14	28	13	6,2	3,4	Sarı / Yellow	100	<b>2,6500</b>



Malzeme: Bakır, Pirinç Kaplı  
Material: Copper, Brass Plated  
İzolasyon / Isolation PVC

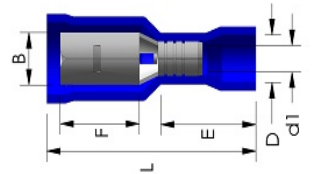

### Dişi Pabuçlar

#### Bullet Female Terminals

Ürün Kodu Product Code	Ürün Adı Product Name	Kesit Cross Sect. (mm <sup>2</sup> )	Ölçüler Dimensions (mm)						Renk Color	Amb. Mik. Pack. Qty (Adet/Pcs.)	Birim Fiyatı Unit Price (TL/Adet)
			B	F	L	E	D	d1			
8018336600	<b>BFT 1040</b>	0,5 - 1,5	3,9	7,3	23,5	10	3,5	1,7	Kırmızı / Red	100	<b>1,3700</b>
008018336610	<b>BFT 2050</b>	1,5 - 2,5	4,9	8,5	25	10	4,2	2,3	Mavi / Blue	100	<b>1,5600</b>
8018336620	<b>BFT 5050</b>	4,0 - 6,0	4,9	8,5	28	13	5,6	3,4	Sarı / Yellow	50	<b>1,7400</b>



Malzeme: Bakır, Pirinç Kaplı  
Material: Copper, Brass Plated  
İzolasyon / Isolation PVC

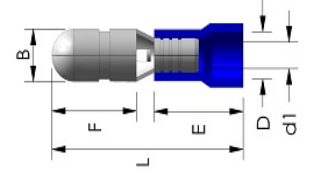

## Erkek Pabuçlar

### Bullet Male Terminals

Ürün Kodu Product Code	Ürün Adı Product Name	Kesit Cross Sect. (mm <sup>2</sup> )	Ölçüler Dimensions (mm)						Renk Color	Amb. Mik. Pack. Qty (Adet/Pcs.)	Birim Fiyatı Unit Price (TL/Adet)
			B	F	L	E	D	d1			
8018336700	<b>BMT 1040</b>	0,5 - 1,5	4	8,5	21	10	3,5	1,7	Kırmızı / Red	100	<b>1,0200</b>
8018336710	<b>BMT 2050</b>	1,5 - 2,5	5	9	21,5	10	4,2	2,3	Mavi / Blue	100	<b>1,2400</b>
8018336720	<b>BMT 5050</b>	4,0 - 6,0	5	9	24,5	13	5,6	3,4	Sarı / Yellow	100	<b>1,4100</b>



Malzeme: Bakır, Kalay Kaplı  
Material: Copper, Tin Plated  
İzolasyon / Isolation PVC

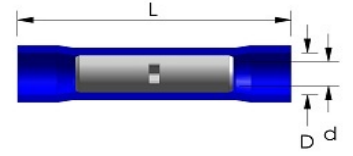

## Ek Muflar

### Insulated Butt Terminals

Ürün Kodu Product Code	Ürün Adı Product Name	Kesit Cross Sect. (mm <sup>2</sup> )	Ölçüler Dimensions (mm)			Renk Color	Amb. Mik. Pack. Qty (Adet/Pcs.)	Birim Fiyatı Unit Price (TL/Adet)
			L	D	d			
8018336500	<b>IBT 251</b>	0,5 - 1,5	24,5	4,3	1,7	Kırmızı / Red	100	<b>1,6300</b>
8018336510	<b>IBT 252</b>	1,5 - 2,5	24,5	4,8	2,3	Mavi / Blue	100	<b>1,9000</b>
8018336520	<b>IBT 256</b>	4,0 - 6,0	27	6,2	3,4	Sarı / Yellow	75	<b>2,8800</b>

### Ledli Sinyal Lambaları - Ø22 mm

#### LED Indicators - Ø22 mm

Ürün Kodu Product Code	Ürün Adı Product Name	Nominal Gerilim Nominal Voltage (V)	Renk Color	Amb. Mik. Pack. Qty (Adet/Pcs.)	Birim Fiyatı Unit Price (TL/Adet)	
8026078912	SIL22-220 Kırmızı Sinyal Lambası Ledli	SIL22-220 Red Signal Lamp with LED	220V AC	●	25	25,50
8026078915	SIL22-220 Yeşil Sinyal Lambası Ledli	SIL22-220 Green Signal Lamp with LED	220V AC	●	25	25,50
8026078914	SIL22-220 Sarı Sinyal Lambası Ledli	SIL22-220 Yellow Signal Lamp with LED	220V AC	●	25	25,50
8026078916	SIL22-220 Mavi Sinyal Lambası Ledli	SIL22-220 Blue Signal Lamp with LED	220V AC	●	25	26,50
8026078919	SIL22-220 Beyaz Sinyal Lambası Ledli	SIL22-220 White Signal Lamp with LED	220V AC	○	25	26,50
8026078922	SIL22-220DC Kırmızı Sinyal Lambası Ledli	SIL22-220DC Red Signal Lamp with LED	220V DC	●	25	25,50
8026078925	SIL22-220DC Yeşil Sinyal Lambası Ledli	SIL22-220DC Green Signal Lamp with LED	220V DC	●	25	25,50
8026078924	SIL22-220DC Sarı Sinyal Lambası Ledli	SIL22-220DC Yellow Signal Lamp with LED	220V DC	●	25	25,50
8026078926	SIL22-220DC Mavi Sinyal Lambası Ledli	SIL22-220DC Blue Signal Lamp with LED	220V DC	●	25	26,50
8026078929	SIL22-220DC Beyaz Sinyal Lambası Ledli	SIL22-220DC White Signal Lamp with LED	220V DC	○	25	26,50
8026078932	SIL22-110 Kırmızı Sinyal Lambası Ledli	SIL22-110 Red Signal Lamp with LED	110V AC/DC	●	25	25,50
8026078935	SIL22-110 Yeşil Sinyal Lambası Ledli	SIL22-110 Green Signal Lamp with LED	110V AC/DC	●	25	25,50
8026078934	SIL22-110 Sarı Sinyal Lambası Ledli	SIL22-110 Yellow Signal Lamp with LED	110V AC/DC	●	25	25,50
8026078936	SIL22-110 Mavi Sinyal Lambası Ledli	SIL22-110 Blue Signal Lamp with LED	110V AC/DC	●	25	26,50
8026078939	SIL22-110 Beyaz Sinyal Lambası Ledli	SIL22-110 White Signal Lamp with LED	110V AC/DC	○	25	26,50
8026078942	SIL22-24 Kırmızı Sinyal Lambası Ledli	SIL22-24 Red Signal Lamp with LED	24V AC/DC	●	25	25,50
8026078945	SIL22-24 Yeşil Sinyal Lambası Ledli	SIL22-24 Green Signal Lamp with LED	24V AC/DC	●	25	25,50
8026078944	SIL22-24 Sarı Sinyal Lambası Ledli	SIL22-24 Yellow Signal Lamp with LED	24V AC/DC	●	25	25,50
8026078946	SIL22-24 Mavi Sinyal Lambası Ledli	SIL22-24 Blue Signal Lamp with LED	24V AC/DC	●	25	26,50
8026078949	SIL22-24 Beyaz Sinyal Lambası Ledli	SIL22-24 White Signal Lamp with LED	24V AC/DC	○	25	26,50



SIL22-24 Beyaz/White

SIL22-24 Kırmızı/Red

SIL22-220 Mavi/Blue

SIL22-220 Sarı/Yellow

SIL22-220 Yeşil/Green

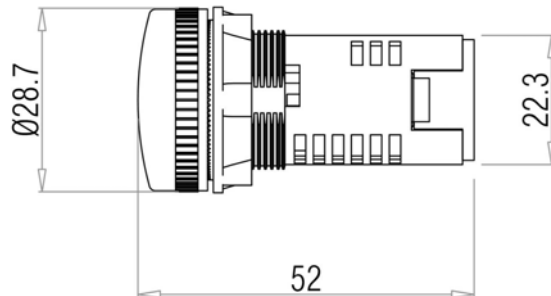

### Yaylı Kumanda Butonları - Ø22 mm

#### Push Buttons Spring Return - Ø22 mm

Ürün Kodu Product Code	Ürün Adı Product Name	Kontakt Contact	Renk Color	Amb. Mik. Pack. Qty (Adet/Pcs.)	Birim Fiyatı Unit Price (TL/Adet)
8025078002	PSR-1C Kırmızı Düz Yaylı Tip 1 NK	PSR-1C Red Spring Return 1 NK	●	15	45,00
8025078075	PSR-10 Yeşil Düz Yaylı Tip 1 NA	PSR-10 Green Spring Return 1 NO	●	15	45,00
8025078104	PSR-10 Sarı Düz Yaylı Tip 1 NA	PSR-10 Yellow Spring Return 1 NO	●	15	45,00
8025078106	PSR-10 Mavi Düz Yaylı Tip 1 NA	PSR-10 Blue Spring Return 1 NO	●	15	45,00
8025078109	PSR-10 Beyaz Düz Yaylı Tip 1 NA	PSR-10 White Spring Return 1 NO	○	15	45,00
8025078100	PSR-10 Siyah Düz Yaylı Tip 1 NA	PSR-10 Black Spring Return 1 NO	●	15	45,00

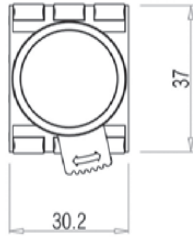
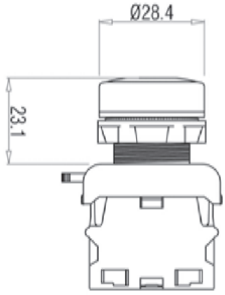

PSR-10 Sarı/Yellow



PSR-1C Kırmızı/Red



PSR-1C Yeşil/Green

### Yaylı Kumanda Butonları - Ø22 mm - Kromajlı Seri

#### Push Buttons Spring Return Chromated - Ø22 mm

Ürün Kodu Product Code	Ürün Adı Product Name	Kontakt Contact	Renk Color	Amb. Mik. Pack. Qty (Adet/Pcs.)	Birim Fiyatı Unit Price (TL/Adet)
8025078062	PSRC-1C Kırmızı Düz Yaylı Tip 1 NK Kromajlı	PSRC-1C Red Spring Return 1 NC Chromated	●	15	46,00
8025078105	PSRC-10 Yeşil Düz Yaylı Tip 1 NA Kromajlı	PSRC-10 Green Spring Return 1 NO Chromated	●	15	46,00
8025078114	PSRC-10 Sarı Düz Yaylı Tip 1 NA Kromajlı	PSRC-10 Yellow Spring Return 1 NO Chromated	●	15	46,00
8025078116	PSRC-10 Mavi Düz Yaylı Tip 1 NA Kromajlı	PSRC-10 Blue Spring Return 1 NO Chromated	●	15	46,00
8025078119	PSRC-10 Beyaz Düz Yaylı Tip 1 NA Kromajlı	PSRC-10 White Spring Return 1 NO Chromated	○	15	46,00
8025078110	PSRC-10 Siyah Düz Yaylı Tip 1 NA Kromajlı	PSRC-10 Black Spring Return 1 NO Chromated	●	15	46,00

### LED'li Yaylı Kumanda Butonları - Ø 22 mm

#### Push Buttons Spring Return LED - Ø 22 mm

Ürün Kodu Product Code	Ürün Adı Product Name	Nominal Gerilim (V) Nominal Voltage (V)	Renk Color	Amb. Mik. Pack. Qty (Adet/Pcs.)	Birim Fiyatı Unit Price (TL/Adet)
8025078022	PSRL-1C 220 Kırmızı Düz Yaylı Tip 1 NK Ledli	220 V AC/DC	●	15	86,00
8025078085	PSRL-1O 220 Yeşil Düz Yaylı Tip 1 NA Ledli	220 V AC/DC	●	15	86,00
8025078224	PSRL-1O 220 Sarı Düz Yaylı Tip 1 NA Ledli	220 V AC/DC	●	15	86,00
8025078226	PSRL-1O 220 Mavi Düz Yaylı Tip 1 NA Ledli	220 V AC/DC	●	15	86,00
8025078229	PSRL-1O 220 Beyaz Düz Yaylı Tip 1 NA Ledli	220 V AC/DC	○	15	86,00
8025078032	PSRL-1C 110 Kırmızı Düz Yaylı Tip 1 NK Ledli	110 V AC/DC	●	15	86,00
8025078095	PSRL-1O 110 Yeşil Düz Yaylı Tip 1 NA Ledli	110 V AC/DC	●	15	86,00
8025078234	PSRL-1O 110 Sarı Düz Yaylı Tip 1 NA Ledli	110 V AC/DC	●	15	86,00
8025078236	PSRL-1O 110 Mavi Düz Yaylı Tip 1 NA Ledli	110 V AC/DC	●	15	86,00
8025078239	PSRL-1O 110 Beyaz Düz Yaylı Tip 1 NA Ledli	110 V AC/DC	○	15	86,00
8025078042	PSRL-1C 48 Kırmızı Düz Yaylı Tip 1 NK Ledli	48 V AC/DC	●	15	86,00
8025078205	PSRL-1O 48 Yeşil Düz Yaylı Tip 1 NA Ledli	48 V AC/DC	●	15	86,00
8025078204	PSRL-1O 48 Sarı Düz Yaylı Tip 1 NA Ledli	48 V AC/DC	●	15	86,00
8025078206	PSRL-1O 48 Mavi Düz Yaylı Tip 1 NA Ledli	48 V AC/DC	●	15	86,00
8025078209	PSRL-1O 48 Beyaz Düz Yaylı Tip 1 NA Ledli	48 V AC/DC	○	15	86,00
8025078052	PSRL-1C 24 Kırmızı Düz Yaylı Tip 1 NK Ledli	24 V AC/DC	●	15	86,00
8025078215	PSRL-1O 24 Yeşil Düz Yaylı Tip 1 NA Ledli	24 V AC/DC	●	15	86,00
8025078214	PSRL-1O 24 Sarı Düz Yaylı Tip 1 NA Ledli	24 V AC/DC	●	15	86,00
8025078216	PSRL-1O 24 Mavi Düz Yaylı Tip 1 NA Ledli	24 V AC/DC	●	15	86,00
8025078219	PSRL-1O 24 Beyaz Düz Yaylı Tip 1 NA Ledli	24 V AC/DC	○	15	86,00

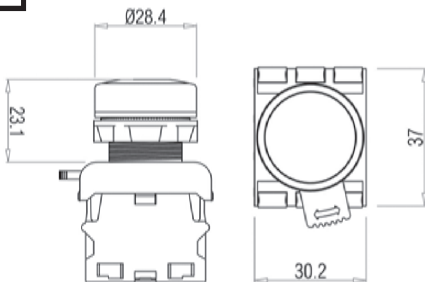

PSRL-1C Kırmızı/Red



PSRL-1O Yeşil/Green



PSRL-1O Mavi/Blue



### LED'li Yaylı Kumanda Butonları - Ø 22 mm Kromajlı

#### Buttons Spring Return LED Chromated - Ø22 mm

Ürün Kodu Product Code	Ürün Adı Product Name	Nominal Gerilim (V) Nominal Voltage (V)	Renk Color	Amb. Mik. Pack. Qty (Adet/Pcs.)	Birim Fiyatı Unit Price (TL/Adet)
8025078322	PSRLC-1C 220 Kırmızı Düz Yaylı Tip 1 NK Ledli- Kromajlı	220 V AC/DC	●	15	89,50
8025078325	PSRLC-1O 220 Yeşil Düz Yaylı Tip 1 NA Ledli- Kromajlı	220 V AC/DC	●	15	89,50
8025078324	PSRLC-1O 220 Sarı Düz Yaylı Tip 1 NA Ledli- Kromajlı	220 V AC/DC	●	15	89,50
8025078326	PSRLC-1O 220 Mavi Düz Yaylı Tip 1 NA Ledli- Kromajlı	220 V AC/DC	●	15	89,50
8025078329	PSRLC-1O 220 Beyaz Düz Yaylı Tip 1 NA Ledli- Kromajlı	220 V AC/DC	○	15	89,50
8025078332	PSRLC-1C 110 Kırmızı Düz Yaylı Tip 1 NK Ledli- Kromajlı	110 V AC/DC	●	15	89,50
8025078335	PSRLC-1O 110 Yeşil Düz Yaylı Tip 1 NA Ledli- Kromajlı	110 V AC/DC	●	15	89,50
8025078334	PSRLC-1O 110 Sarı Düz Yaylı Tip 1 NA Ledli- Kromajlı	110 V AC/DC	●	15	89,50
8025078336	PSRLC-1O 110 Mavi Düz Yaylı Tip 1 NA Ledli- Kromajlı	110 V AC/DC	●	15	89,50
8025078339	PSRLC-1O 110 Beyaz Düz Yaylı Tip 1 NA Ledli- Kromajlı	110 V AC/DC	○	15	89,50
8025078342	PSRLC-1C 48 Kırmızı Düz Yaylı Tip 1 NK Ledli- Kromajlı	48 V AC/DC	●	15	89,50
8025078345	PSRLC-1O 48 Yeşil Düz Yaylı Tip 1 NA Ledli- Kromajlı	48 V AC/DC	●	15	89,50
8025078344	PSRLC-1O 48 Sarı Düz Yaylı Tip 1 NA Ledli- Kromajlı	48 V AC/DC	●	15	89,50
8025078346	PSRLC-1O 48 Mavi Düz Yaylı Tip 1 NA Ledli- Kromajlı	48 V AC/DC	●	15	89,50
8025078349	PSRLC-1O 48 Beyaz Düz Yaylı Tip 1 NA Ledli- Kromajlı	48 V AC/DC	○	15	89,50
8025078352	PSRLC-1C 24 Kırmızı Düz Yaylı Tip 1 NK Ledli- Kromajlı	24 V AC/DC	●	15	89,50
8025078355	PSRLC-1O 24 Yeşil Düz Yaylı Tip 1 NA Ledli- Kromajlı	24 V AC/DC	●	15	89,50
8025078354	PSRLC-1O 24 Sarı Düz Yaylı Tip 1 NA Ledli- Kromajlı	24 V AC/DC	●	15	89,50
8025078356	PSRLC-1O 24 Mavi Düz Yaylı Tip 1 NA Ledli- Kromajlı	24 V AC/DC	●	15	89,50
8025078359	PSRLC-1O 24 Beyaz Düz Yaylı Tip 1 NA Ledli- Kromajlı	24 V AC/DC	○	15	89,50

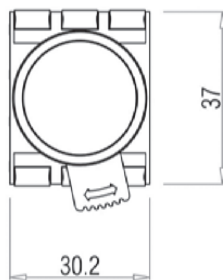
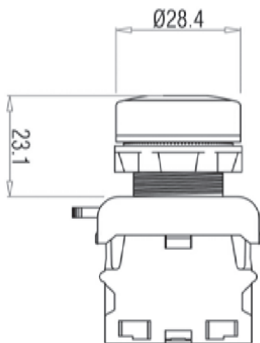





PSRLC-1C Kırmızı/Red



PSRLC-1O Yeşil/Green

Çiftli, Yaylı Kumanda Butonları - Ø 22 mm

Double Spring Push Button - Ø22 mm

Ürün Kodu Product Code	Ürün Adı Product Name	Kontakt Contact	Renk Color	Amb. Mik. Pack. Qty (Adet/Pcs.)	Birim Fiyatı Unit Price (TL/Adet)
8025078302	DSR-1C10 Çiftli Yaylı Tip 1NA+1NK	DSR-1C10 Double Spring Return 1NO+1NC		10	69,00
8025078700	DSRC-1C10 Çiftli Yaylı Tip 1NA+1NK Kromajlı	DSRC-1C10 Double Spring Return 1NO+1NC Chromated		10	76,00
8025078312	DSRL-1C10 220 Çiftli Yaylı Tip 1NA+1NK Ledli	DSRL-1C10 220 Double Spring Return 1NO+1NC with LED		10	109,00
8025078362	DSRL-1C10 110 Çiftli Yaylı Tip 1NA+1NK Ledli	DSRL-1C10 110 Double Spring Return 1NO+1NC with LED		10	109,00
8025078372	DSRL-1C10 24 Çiftli Yaylı Tip 1NA+1NK Ledli	DSRL-1C10 24 Double Spring Return 1NO+1NC with LED		10	109,00

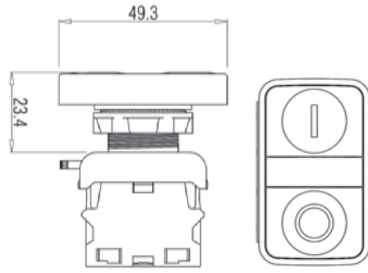

DSR-1C10

Acil Stop Kumanda Butonları - Ø 22 mm

Emergency Stop - Ø 22 mm

Ürün Kodu Product Code	Ürün Adı Product Name	Kontakt Contact	Renk Color	Amb. Mik. Pack. Qty (Adet/Pcs.)	Birim Fiyatı Unit Price (TL/Adet)
8025078012	EPB-1C Acil Stop 1 NK	EPB-1C Emergency Stop 1 NC		10	55,00

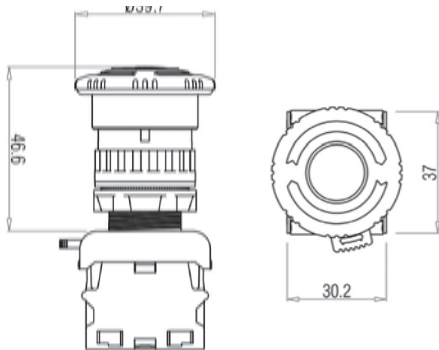

EPB-1C

#### Kalıcı Tip Seçici Butonlar - Ø 22 mm

#### Selector Switches Maintained - Ø22 mm

Ürün Kodu Product Code	Ürün Adı Product Name	Kontakt Contac	Renk Color	Pozisyon Position	Amb. Mik. Pack. Qty (Adet/Pcs.)	Birim Fiyatı Unit Price (TL/Adet)
8025078500	SSP-10 Kalıcı 0-1 Seçici Buton	1 NA	●	0 1	12	49,00
8025078510	SSP-20 Kalıcı 1-0-2 Seçici Buton	2 NA	●	1 0 2	12	64,50
8025078710	SSPC-10 Kalıcı 0-1 Seçici Buton - Kromajlı	1 NA	●	0 1	12	58,00
8025078720	SSPC-20 Kalıcı 1-0-2 Seçici Buton - Kromajlı	2 NA	●	1 0 2	12	70,00

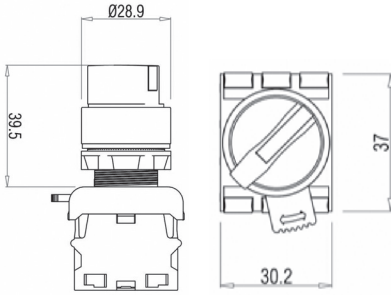

SSPC-20



SSP-20

#### Yay Dönüslü Seçici Butonlar - Ø 22 mm

#### Selector Switch Momentary - Ø22 mm

Ürün Kodu Product Code	Ürün Adı Product Name	Kontakt Contact	Renk Color	Pozisyon Position	Amb. Mik. Pack. Qty (Adet/Pcs.)	Birim Fiyatı Unit Price (TL/Adet)
8025078320	SSM-10 Yay Dönüslü 0-1 Seçici Buton	1 NA	●	0 1	12	53,00
8025078330	SSM-20 Yay Dönüslü 1-0-2 Seçici Buton	2 NA	●	1 0 2	12	72,50
8025078340	SSMC-10 Yay Dönüslü 0-1 Seçici Buton - Kromajlı	1 NA	●	0 1	12	57,50
8025078350	SSMC-20 Yay Dönüslü 1-0-2 Seçici Buton - Kromajlı	2 NA	●	1 0 2	12	76,00

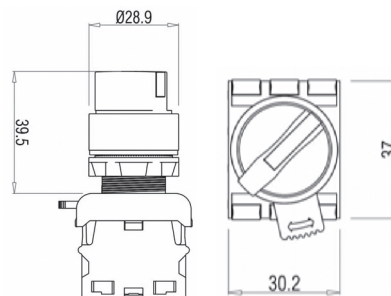

SSM-10

### LED'li Kalıcı Tip Seçici Butonlar - Ø 22 mm

Selector Switches Maintained with LED - Ø22 mm

Ürün Kodu Product Code	Ürün Adı Product Name	Nominal Gerilim (V) Nominal Voltage (V)	Renk Color	Pozisyon Position	Amb. Mik. Pack. Qty (Adet/Pcs.)	Birim Fiyatı Unit Price (TL/Adet)
8025078602	SSP-10 220 L Kırmızı Kalıcı Işıklı 0-1 Seçici Buton	220 V AC/DC	Red	0 1	12	92,00
8025078605	SSP-10 220 L Yeşil Kalıcı Işıklı 0-1 Seçici Buton	220 V AC/DC	Green	0 1	12	92,00
8025078604	SSP-10 220 L Sarı Kalıcı Işıklı 0-1 Seçici Buton	220 V AC/DC	Yellow	0 1	12	92,00
8025078622	SSP-20 220 L Kırmızı Kalıcı Işıklı 1-0-2 Seçici Buton	220 V AC/DC	Red	1 0 2	12	109,00
8025078615	SSP-20 220 L Yeşil Kalıcı Işıklı 1-0-2 Seçici Buton	220 V AC/DC	Green	1 0 2	12	109,00
8025078614	SSP-20 220 L Sarı Kalıcı Işıklı 1-0-2 Seçici Buton	220 V AC/DC	Yellow	1 0 2	12	109,00

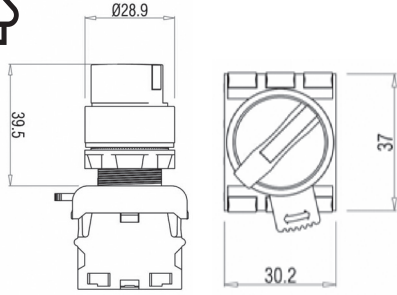

SSP-10 220 L Yeşil/Green



SSP-10 220 L Kırmızı/Red

### LED'li Tip Yay Dönüslü Seçici Butonlar - Ø 22 mm

Selector Switch Momentary with LED - Ø22 mm

Ürün Kodu Product Code	Ürün Adı Product Name	Nominal Gerilim (V) Nominal Voltage (V)	Renk Color	Pozisyon Position	Amb. Mik. Pack. Qty (Adet/Pcs.)	Birim Fiyatı Unit Price (TL/Adet)
8025078402	SSM-10 220 L Kırmızı Yay Dönüslü Işıklı 0-1 Seçici Buton	220 V AC/DC	Red	0 1	12	86,00
8025078405	SSM-10 220 L Yeşil Yay Dönüslü Işıklı 0-1 Seçici Buton	220 V AC/DC	Green	0 1	12	86,00
8025078404	SSM-10 220 L Sarı Yay Dönüslü Işıklı 0-1 Seçici Buton	220 V AC/DC	Yellow	0 1	12	86,00
8025078422	SSM-20 220 L Kırmızı Yay Dönüslü Işıklı 1-0-2 Seçici Buton	220 V AC/DC	Red	1 0 2	12	109,00
8025078415	SSM-20 220 L Yeşil Yay Dönüslü Işıklı 1-0-2 Seçici Buton	220 V AC/DC	Green	1 0 2	12	109,00
8025078424	SSM-20 220 L Sarı Yay Dönüslü Işıklı 1-0-2 Seçici Buton	220 V AC/DC	Yellow	1 0 2	12	109,00

LED li Kalıcı ve Yaylı Tip Seçici Butonların 110V AC/DC ve 24V AC/DC Nominal Gerilimleri için lütfen satış temsilcinizle irtibata geçiniz.

### Kontakt Blok Tipleri

#### Contact Block Types

Ürün Kodu Product Code	Ürün Adı Product Name	Kontakt Contact	Amb. Mik. Pack. Qty (Adet/Pcs.)	Birim Fiyatı Unit Price (TL/Adet)	
8025078800	CNT-O NA Kontakt	CNT-O NO Contact	1 NA	50	19,00
8025078810	CNT-C NK Kontakt	CNT-C NC Contact	1 NK	50	19,00
8025078820	CNT-S Işık Kontakt Blok	CNT-S Signal Contact	50	22,00	

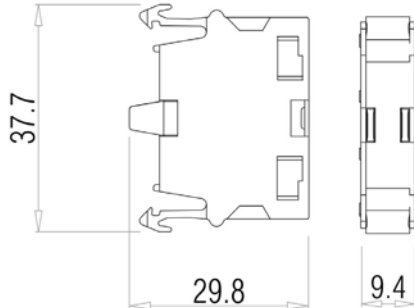

CNT-O / CNT-C

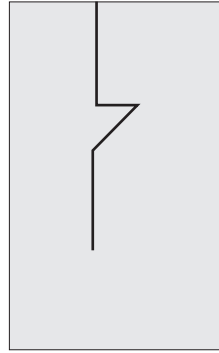

NK/NC  
Kontakt/Contact

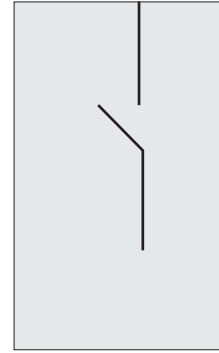

NA/NO  
Kontakt/Contact

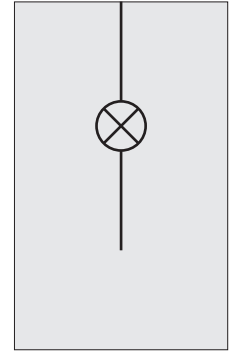

Sinyal Kontakt  
Signal Contact



CNT-S



#### Teknik Bilgiler / Technical Information

Standart / Standard	IEC 60947-5-1
Çalışma Sıcaklığı min/maks. / Operating Temperature min/max (°C)	-5 / +40
Kirlilik Derecesi / Pollution Severity	3
Yalıtım Gerilimi / Rated insulation voltage (V)	400
Darbe Beyan Gerilimi / Rated impulse withstand voltage (kV)	4
Klasik Açık hava Termal Akım / Conventional Thermal Current (A)	10
Kullanım Sınıfı / Utilization Category	AC 15

Nominal Çalışma Gerilimi / Rated Operational Voltage (V)	Nominal Çalışma Akımı / Rated Operational Current (A)
380	1,9
240	3
120	6





**MERKEZ****Tbloc Elektrik Elektronik San. ve Tic. A.Ş.**

29 Ekim Mahallesi 10001 Sokak No: 50/4

35663 Menemen İzmir Turkey

Tel: +90 232 833 26 96

Fax: +90 232 833 26 97

**İSTANBUL AVRUPA BÖLGE**

Gsm: +90 539 599 20 38

E-mail: istanbulavrupa@tbloc.com.tr

**İSTANBUL ANADOLU BÖLGE**

Gsm: +90 530 259 67 50

E-mail: istanbulanadolu@tbloc.com.tr

**GÜNEY MARMARA BÖLGESİ**

Gsm: +90 539 599 19 54

E-mail: guneymarmara@tbloc.com.tr

**EGE BÖLGE**

Gsm: +90 539 776 08 15

E-mail: egebolge@tbloc.com.tr

**İÇ ANADOLU BÖLGE**

Gsm: +90 539 599 18 02

E-mail: icanadolubolge@tbloc.com.tr

**info@tbloc.com.tr**

**www.tbloc.com.tr**

**YETKİLİ SATICI**

--